

MAINTENANCE WORKTOP 020



**BONDIOLI
& PAVESI** 

© BONDIOLI & PAVESI SpA

No part of this manual may be reproduced
without specific permission from Bondioli & Pavesi.

All data and codes contained in this catalog replace and supersede any information given by previous publications. Consequently data provided in previous publications may no longer be valid. Bondioli & Pavesi reserves the right to change specifications without prior notice or obligation.

Operator's manual
MAINTENANCE
WORKTOP
020

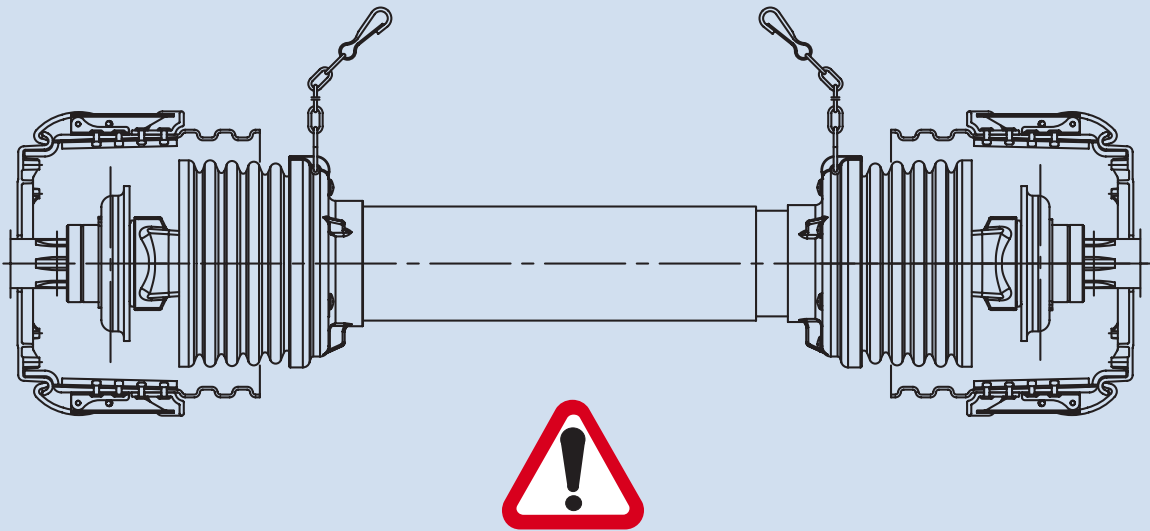

All rotating parts must be guarded.
The tractor master shield, the driveline guards, and the implement input connection shields form an interactive guarding system.

Proper use and maintenance of the driveline and shielding is of primary importance for operator safety.

A high percentage of driveline accidents occur when safety shielding is missing or does not function properly.

Bondioli & Pavesi recommends the use of proper shields and guards for the driveline, tractor, and implement. Damaged or missing components must be replaced with original equipment spare parts, correctly installed, before using the driveline.

Use the implement only with the original driveline. The implement input connection shield must be compatible with the driveline and the application.

To comply with international safety standards, the implement manufacturer shall provide safety sign(s) and instructions stating that guards must be kept in place and the machine should not be operated with guards opened or removed. These sign(s) should be used to draw attention to the possible risks when the guard is unlocked, opened, or removed.

In addition it is recommended that the implement manufacturer provide a list of the guards, their corresponding warnings, their positions, and spare parts codes in the instruction manual.

Basic information for safe and correct use of the driveline and shielding are shown in our catalogs and in the instruction sheet provided with Bondioli & Pavesi drivelines. Safety labels and user's manuals in alternative languages are available to meet local requirements.

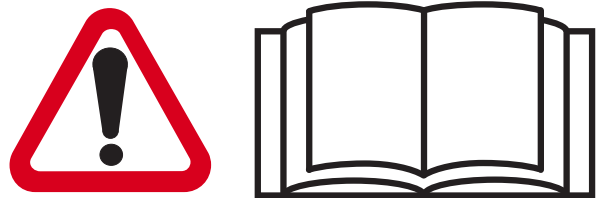

**THE ABOVE INFORMATION
CONCERNS YOUR SAFETY**

Safety and working conditions



Use the implement only with the original driveline, which is compatible in length, power capacity, torque limiters, overrunning clutches, and shielding. The driveline and safety devices are designed specifically for the implement, and should be used exclusively for this purpose.

Do not exceed the speed and power limits given by the operator's manual. Drivelines, torque limiters, and overrunning clutches in this catalog are designed to be used at speeds that do not exceed 1000 min⁻¹.

Do not overload the implement or suddenly engage the PTO clutch. Any torque limiter or clutch should be installed on the implement end of the driveline. Use the driveline, torque limiters, and overrunning clutches only for their intended purpose.

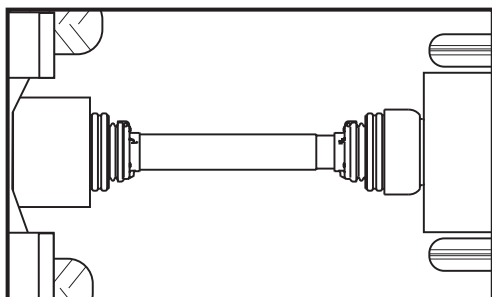

All rotating parts must be guarded. Contact with a rotating driveline can cause death or serious injury. The tractor master shield, the driveline guards, and the implement input connection shield form an interactive guarding system.

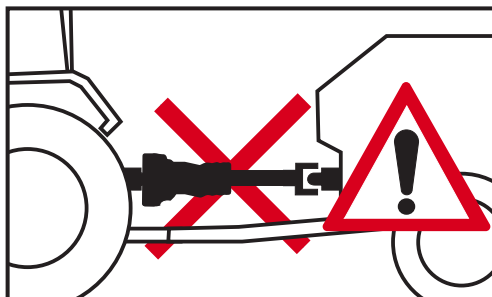

Ensure that all driveline, tractor, and implement shields are functional and in place before operation. Damaged or missing parts must be replaced with the original equipment spare parts, correctly installed, before using the driveline.

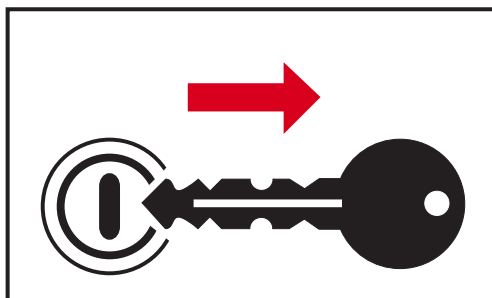

Disengage the PTO, turn off the tractor engine, remove the key, and check that all rotating parts have come to a standstill before approaching the implement or performing maintenance work.

Safety and working conditions



Do not approach, nor allow bystanders to come near the work zone or rotating parts. Do not wear loose clothing, jewelry, hair, or anything which could get caught in the machine. Contact with rotating parts could cause serious injury or death.



Do not stand, lean, or otherwise come in contact with the driveline. Do not step over or go under the driveline.

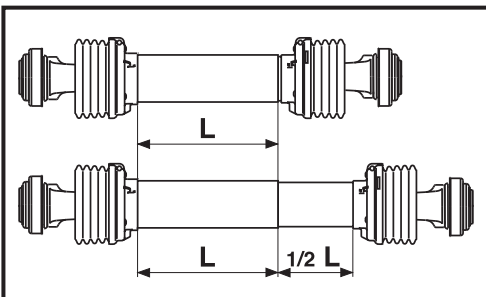

Keep the profile tubes overlapped as much as possible during transport and operation. Do not exceed the values given in this catalog for permissible length extension. If greater telescoping ability is required, contact Bondioli & Pavesi engineering.

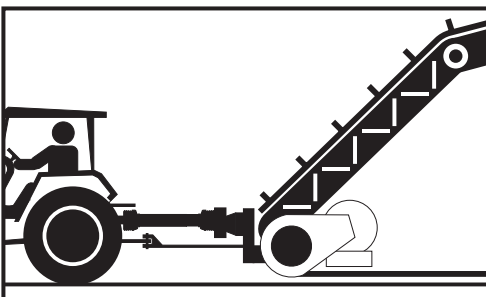

Always hitch the tractor to STATIONARY MACHINERY (pumps, hoists, generators, dryers, etc.). Check the tractor wheels to prevent rolling and check that joint angles are small and as equal as possible.

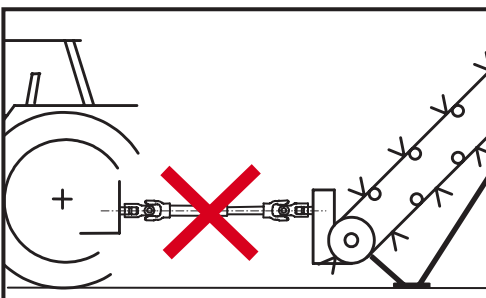

Always hitch the tractor to STATIONARY MACHINERY (pumps, hoists, generators, dryers, etc.) so that the profile tubes are not overextended. Under all working conditions, extension of the driveline should not exceed the values reported in this catalog. All rotating parts must be guarded.

Safety and working conditions

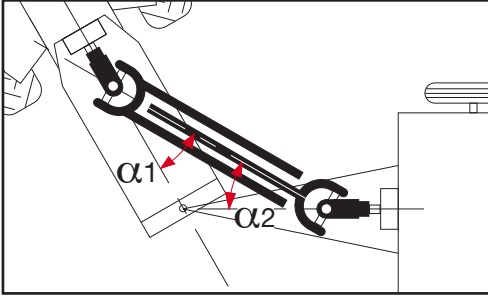

SINGLE CARDAN JOINTS

When operating, ensure that angles α_1 and α_2 are small and as equal as possible. The joint angles may vary widely during turns, but must never exceed 35° under power or 45° while rotating. Disengage the PTO when the joint angles become excessive or too unequal. See "Driveline Applications" for more information.

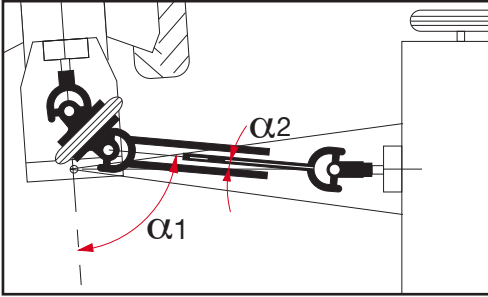

CONSTANT VELOCITY JOINTS

Constant velocity joint can allow large joint angles up to 50° or 80° depending upon the type. These joint angles should only be allowed for brief periods, for example during turning.

For drivelines with a constant velocity joint on the tractor side and a single cardan joint on the implement side, the maximum recommended angles of the single joint are 16° at 540 min^{-1} and 9° at 1000 min^{-1} to prevent irregular motion. See "Driveline Applications" for more information.

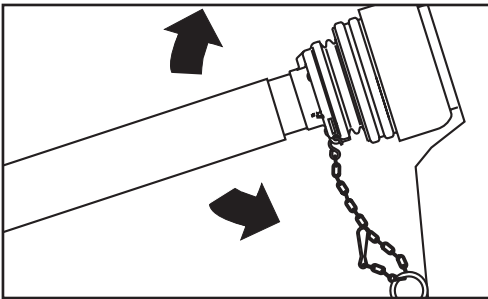

Attach the shield restraint chains, allowing sufficient slack for the driveline to move during turns and operation.

Best results are achieved when the chains are attached nearly perpendicular to the driveline guard. Adjust the length to allow articulation of the driveline in working or transport positions, but avoid excessive slack that may wrap around the driveline.

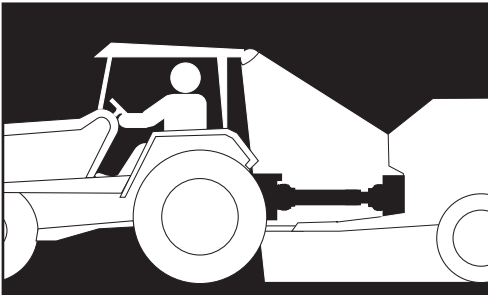

When used at night or in poor visibility, illuminate the driveline operating area.

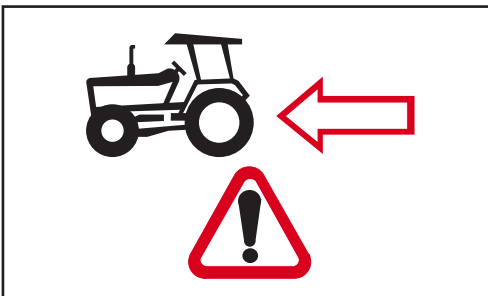

The tractor printed on the shield indicates the tractor end of the driveline. Any torque limiter or overrunning clutch must be installed on the implement end of the driveline.

Safety and working conditions

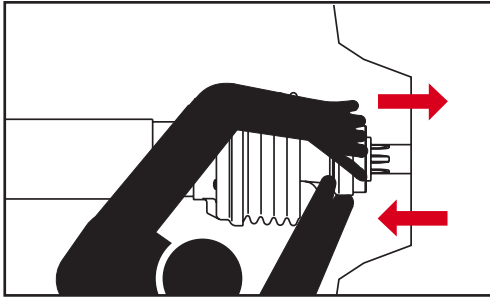

Ensure that the driveline is securely attached to the tractor and the implement before operating.
Check that all bolts or nuts are properly torqued.

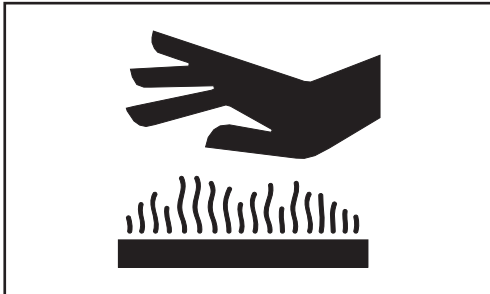

Friction clutches may become hot during use.

Do not touch!

Keep the area around the friction clutch clear of any material which could catch fire and avoid prolonged slipping.

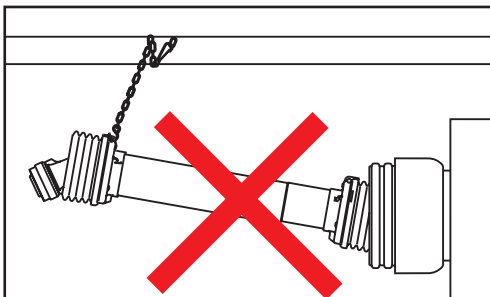

Never use the shield restraint chains to support the driveline for storage.
Always use the support on the implement.

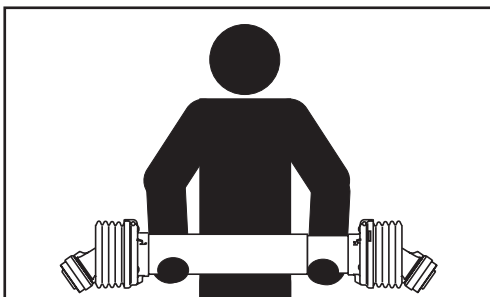

Keep the driveline horizontal during handling to prevent the halves from sliding apart, which could cause injury or damage the shielding. Use suitable means to transport the driveline, depending on the weight.

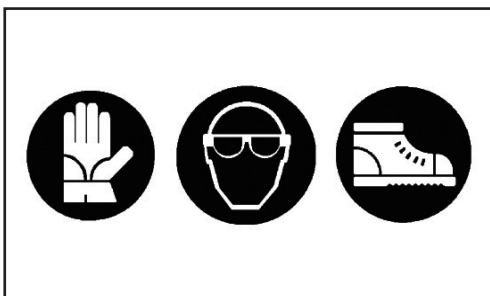

Always wear adequate safety equipment when performing any maintenance or repair work.

Clean and grease the PTO of the tractor and the implement input connection to facilitate installation of the driveline.

Replace worn or damaged components with the original Bondioli & Pavesi spare parts. Do not alter or tamper with any driveline component. Contact an authorized Bondioli & Pavesi dealer concerning any operations not described in the instruction manual.

Hydraulic maintenance worktop

3978038010

Full hydraulic bench for universal joint repair



Hydraulic maintenance worktop

TOOLS

398014000

Punch tool set



397003000R Ø6
397004000R Ø8
397005000R Ø10

398015000

Snap ring pliers



397001000R Plier J21
397002000R Plier J31

398067000

Punches and bushes set for joint assembly and disassembly press



Punches	bearing Ø
397067001R	20.0
397062000R	22.0
397063000R	23.8
397064000R	27.0
397065000R	30.2
397066000R	34.9
397067000R	41.0-42.0
397067002R	42.0
397067003R	49.0-50.0

Bushes	bearing Ø
397073001R	20.0
397068000R	22.0
397069000R	23.8
397070000R	27.0
397071000R	30.2
397072000R	34.9
397073000R	41.0-42.0
397073002R	42.0
397073003R	49.0-50.0

Hydraulic maintenance worktop

TOOLS

398018001

Plug gauge set to check yoke bearing housing concentricity



Plug gauges	bearing Ø
397084000R	22.0
397085000R	23.8
397086000R	27.0
397087000R	30.2
397088000R	34.9
397089000R	41.0
397096000R	42.0
397083000R	Handle
397082001R	Support

398012000

Ratchet torque limiter assembling tool



398017000

Ratchet torque limiter extractor



397006001R Tube

397007001R Extractor with 1 3/8" z6 spline

397017001R Pin

398024000

Push pin assembling tool



Hydraulic maintenance worktop

TOOLS

398049000

Vice



398054000

Hydraulic press for joint assembly and disassembly



397051000R Mobile support

397039000R Fixed support

397031000R Tool holder counter plate

397188000R Stem guide

398034000

Hydraulic extractor



397018000R Tie rod

397020000R Bracket

397012000R Special screw

397130000R Upper jaw

397131000R Lower jaw

397125000R Mobile plate

397123000R Upper plate

397016000R Knurled wheel

397132000R Lower plate

397128000R Push rod

397129000R Volute

397122000R Special screw

TOOLS

398075000

Bearing extractor
Ø 20.0
Ø 22.8

398076000

Bearing extractor
Ø 23.8
Ø 27.0

398072000

Bearing extractor
Ø 30.2
Ø 34.9

398073000

Bearing extractor
Ø 41.0
Ø 42.0





398CDS005EN00-0421
