

Flow regulator 3 way, pressure compensated

VRFC3

0M.32.03 - X - Y

RE 18309-38

Edition: 03.2016

Replaces: 04.2010

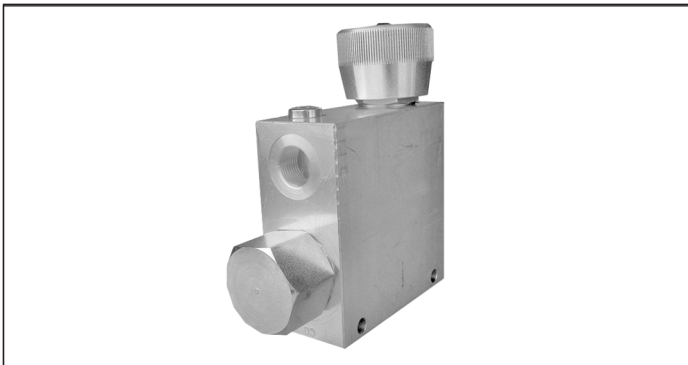

Technical data

Operating pressure	up to 210 bar (3000 psi)
QE= max. inlet flow "E" port (see "Dimensions")	
QR= max. regulated flow "R" port (see "Dimensions")	
Flow range adjustment	0 - 3 turns
Weight	see "Dimensions"
Manifold material	Aluminium
Note: aluminium bodies are often strong enough for operating pressures exceeding 210 bar (3000 psi), depending from the fatigue life expected in the specific application. If in doubt, consult our Service Network.	
Fluid	Mineral oil (HL, HLP) according DIN 51524
Fluid temperature range	-30 °C to 100 (-22 to 212 °F)
Viscosity range	5 to 800 mm ² /s (cSt)
Recommended degree of fluid contamination	Class 19/17/14 according to ISO 4406
Other technical data	see data sheet 18350-50

Note: for applications outside these parameters, please consult us.

Description

A constant flow rate, regardless of system pressures, is established from E to R, while a minimum pressure differential of appr. 5 bar (70 psi) exists between the two ports. Input flow supplied to E in excess of the regulated output at R is by-passed to T. Output flow can be varied from closed to the nominal maximum rating for the valve. Reverse flow from R to E is limited by the selected opening of the restrictor and is not pressure compensated. Flow from T to E or from T to R is not possible. Increasing or decreasing inlet flow may cause slight increase or decrease of Regulated flow.

Characteristic curve

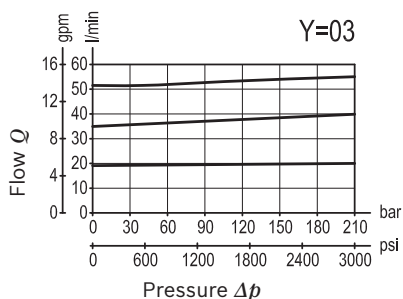
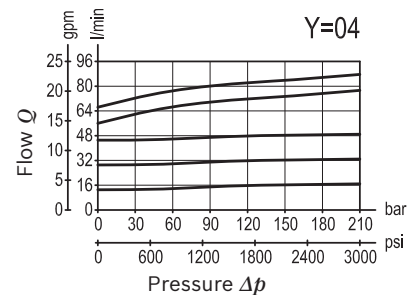
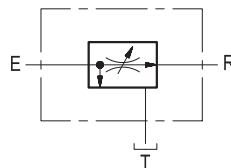
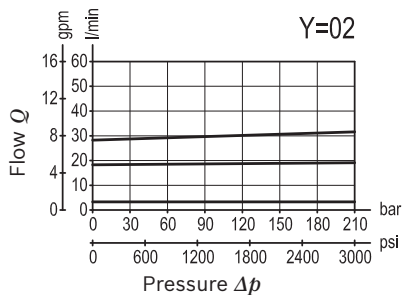



Ordering code

0M.32.03	X	Y
-----------------	----------	----------

Flow regulator
3 way, pressure compensated

Adjustments

70	Handknob and locknut	
80	Screw and locknut	
40	Graduated handknob	

Port sizes	E - R - T
02	G 3/8
03	G 1/2
04	G 3/4

Preferred types

Type	Material number
0M3203700200000	R930004231
0M320370030000A	R930004232
0M3203700400000	R930004233
0M3203800200000	R930004241
0M320380030000A	R930004242
0M3203800400000	R930004244

Type	Material number
0M3203400200000	R930004220
0M320340030000A	R930004221
0M3203400400000	R930004224

Dimensions

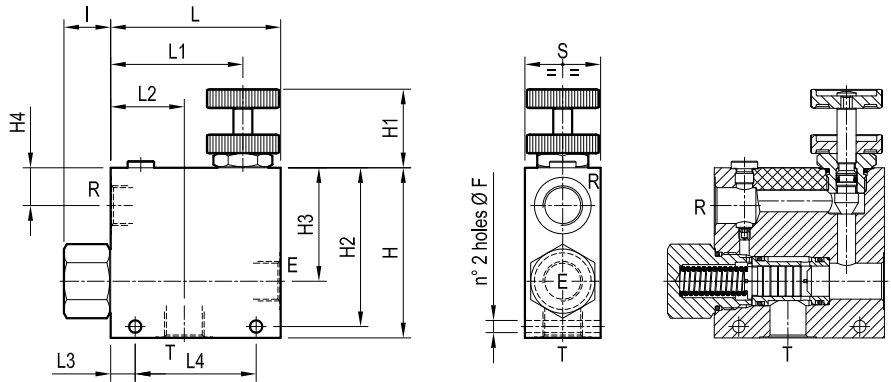

50 (1.97)	88 (3.47)	10 (0.39)	44 (1.73)	79 (3.11)	108 (4.25)	25 (0.98)	23 (0.91)	73 (2.87)	101 (3.98)	40 (1.58)	108 (4.25)	8.5 (0.34)	90 l/min 24 gpm	150 l/min 40 gpm	G 3/4	1.95 (4.3)
40 (1.58)	64 (2.52)	13 (0.51)	39 (1.54)	70 (2.76)	90 (3.54)	25 (0.98)	17.5 (0.69)	60 (2.36)	84 (3.31)	40 (1.58)	90 (3.54)	6.5 (0.26)	55 l/min 24 gpm	90 l/min 24 gpm	G 1/2	1.06 (2.34)
40 (1.58)	64 (2.52)	13 (0.51)	39 (1.54)	70 (2.76)	90 (3.54)	25 (0.98)	17.5 (0.69)	60 (2.36)	84 (3.31)	40 (1.58)	90 (3.54)	6.5 (0.26)	30 l/min 8 gpm	55 l/min 15 gpm	G 3/8	1.06 (2.34)
S	L4	L3	L2	L1	L	I	H4	H3	H2	H1	H	F	QR	QE	Y	Weight kg (lbs)

Bosch Rexroth Oil Control S.p.A.

Via Leonardo da Vinci 5
P.O. Box no. 5
41015 Nonantola – Modena, Italy
Tel. +39 059 887 611
Fax +39 059 547 848
compact-hydraulics-pib@boschrexroth.com
www.boschrexroth.com/compacthydraulics

© This document, as well as the data, specifications and other information set forth in it, are the exclusive property of Bosch Rexroth Oil Control S.p.a.. It may not be reproduced or given to third parties without its consent. The data specified above only serve to describe the product. No statements concerning a certain condition or suitability for a certain application can be derived from our information. The information given does not release the user from the obligation of own judgment and verification. It must be remembered that our products are subject to a natural process of wear and aging. Subject to change.