

IEC Push Button Specifications

Bulletin Numbers 598, 800F, 800FC, 800FD, 800B, 800MB, and 800MR

Topic	Page
800F 22.5 mm Push Buttons	
Specifications	3
Momentary Push Buttons	6
Pilot Lights	10
Selector Switches	11
Key-Operated Selector Switches	16
Push-Pull Operators	18
Momentary Mushroom Push Buttons	22
Momentary Multi-Operators	23
Reset Operators	26
Selector Push Button Operators	27
Toggle Switch Operators	28
Back-of-Panel Components	29
Assembled Stations with DeviceNet	31
Legend Plates/Caps	32
Approximate Dimensions	33
Assembled Station Pinout Chart	39
598 General Purpose Push Button Enclosures	
800FC 22.5 mm Configured Pendant Stations	
Operator Mounting/Sequence	41
1-, 2-, and 3-Speed Operators	42
Configured Pendant Stations	43
Specifications	45
Approximate Dimensions	47

Topic	Page
800FD 22.5 mm Monolithic Push Buttons	
Momentary Push Button Operators	49
Pilot Light Devices	50
Selector Switch Operators	51
Push-Pull/Twist-to-Release Mushroom Operators	51
Specifications	52
Approximate Dimensions	53
800B 16 mm Push Buttons	
Specifications	54
Operator Assembly Sequence/Target Table and Operator Position	55
Approximate Dimensions	56
800MR/800MB IEC Oiltight Operators	
800MR Momentary Contact Push Buttons	57
800MR Push-Pull Operators	59
800MR Selector Switches	61
800MR Pilot Lights & Wobble Sticks	66
800MB Momentary Contact Push Buttons	67
800MB Pilot Lights	70
800MB/MR Specifications	71
800MB/MR Approximate Dimensions	72

Additional Resources

These documents contain additional information concerning related products from Rockwell Automation.

Resource	Description
Industrial Automation Wiring and Grounding Guidelines, publication 1770-4.1	Provides general guidelines for installing a Rockwell Automation industrial system.
Product Certifications website, http://www.ab.com	Provides declarations of conformity, certificates, and other certification details.

You can view or download publications at <http://www.rockwellautomation.com/literature/>. To order paper copies of technical documentation, contact your local Allen-Bradley distributor or Rockwell Automation sales representative.



Bulletin 800FP Plastic Operators

- IP65/66, Type 4/4X/13
- Engineering grade thermoplastics
- Chemical-resistant for harsh environments



Bul. 800FP Plastic Operators

Bulletin 800FM Metal Operators

- IP65/66, Type 4/13
- Die-cast metal construction
- Chrome-plated



Bul. 800FM Die-Cast Metal Operators

3-Across x 2-Deep Back-of-Panel (6 Circuits Max.)

- Rugged snap-fit design for plastic or metal latch
- Stackable contact blocks
- Rotating collar for easy one-hand latch removal
- Color-coded contact block plungers for contact identification



Plastic Latch with Contact Block



Metal Latch with Contact Block

Assembly Overview

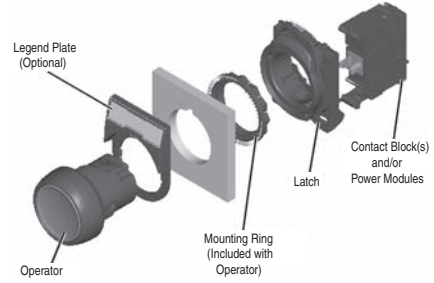

Specifications

Front-of-Panel (Operators)★

Description		Mechanical Ratings	
		Plastic (Bulletin 800FP)	Metal (Bulletin 800FM)
Vibration (assembled to panel)		Tested at 10...2000 Hz, 1.52 mm displacement (peak-to-peak) max./10 G max. for 3 hr duration, no damage	
Shock		Tested at 1/2 cycle sine wave for 11 ms; no damage at 100 G	
Degree of protection‡		IP65/66 (Type 3/3R/4/4X/12/13)	IP65/66 (Type 3/3R/4/12/13)
Mechanical durability per EN 60947-5-1 (Annex C)	10 000 000 Cycles	Momentary push buttons, momentary mushroom	
	1 000 000 Cycles	Multi-function, selector switch, key selector switch, selector jog, SensEject™ key selector switch	
	500 000 Cycles	Non-illuminated push-pull E-stop§	
	300 000 Cycles	Twist-to-release E-stop, illuminated push-pull E-stop§, alternate action push buttons	
	100 000 Cycles	Potentiometer, toggle switch	
Operating forces (typical with one contact block)		Flush/extended = 5 N, E-stop = 36 N Mushroom = 9 N	
Operating torque (typical application with one contact block)		Selector switch = 0.25 N•m (2.2 lb•in)	
Mounting torque	Plastic	1.7 N•m (15 lb•in)	
	Metal	4.4 N•m (40 lb•in)	
Environmental			
Temperature range (operating)		-25...+70 °C (-13...+158 °F)♣	
Temperature range (short term storage)		-40...+85 °C (-40...+185 °F)	
Humidity		50...95% RH from 25...60 °C (77...140 °F)	

★ **Performance Data** — Performance data given in this publication is provided only as a guide for the user in determining suitability and do not constitute a performance warranty of any kind. Such data may represent the results of accelerated testing at elevated stress levels, and the user is responsible for correlating the data to actual application requirements. ALL WARRANTIES AS TO ACTUAL PERFORMANCE, WHETHER EXPRESS OR IMPLIED, ARE EXPRESSLY DISCLAIMED.

‡ Momentary mushroom operators are IP65. Plastic keyed operators are IP66, Type 4/13; not Type 4X.

§ Limit of four contact blocks max. for these devices.

♣ Operating temperatures below 0 °C (32 °F) are based on the absence of freezing moisture and liquids, UL Recognized to 55 °C (131 °F) - Incandescent module max. 40 °C (104 °F).

Standards Compliance and Certifications

Certifications	UR/UL, CSA, CCC, CE
Standards Compliance — CE Marked	NEMA ICS-5; UL 508, EN ISO 13850, EN 60947-1, EN 60947-5-1, EN 60947-5-5
Terminal Identification	EN/IEC 60947-1
Shipping Approvals	ABS
RoHS	✓

Back-of-Panel Components★

		Electrical Ratings		
		Screw Termination	Spring Clamp Termination	
Standard contact block ratings		A600, Q600 600V AC	A300, Q300 300V AC	
Low voltage contact block ratings‡		AC 15, DC 13 to IEC/EN 60947-5-1 and UL 508, 17V, 5 mA min.		
		5V, 1 mA DC min. C300, R150, AC 15, DC 13 to EN 60947-5-1 and UL 508		
Nominal Voltage		Range	Current Draw	Frequency
LED Module Ratings	24...120V AC/DC	20...132V AC/DC	15 mA (AC), 12 mA (DC)	50/60 Hz, DC
	24V AC	10...29V AC	31 mA	50/60 Hz
	24V DC	10...30V DC	24 mA	DC
	120V AC 240V AC	102...132V AC 204...264V AC	6 mA 6 mA	50/60 Hz 50/60 Hz
Thermal current		10 A max. enclosed (40 °C ambient) to UL508, EN 60947-5-1		
Insulation voltage (U _i)		Screw terminal = 690V, spring-clamp = 300V		
Wire capacity (screw terminal)§		#18...12 AWG (0.75...2.5 mm ²) Max. (2) #14 AWG or (1) #12 AWG		
Wire capacity (spring-clamp terminal)		#18...14 AWG (0.75...1.5 mm ²) One per spring clamp, two spring clamps per terminal		
Recommended tightening torque on screw terminals		0.7...0.9 N•m (6...8 lb•in)		
Dielectric strength (minimum)		2500V for one minute		
External short circuit protection	Standard blocks	10 A type gL/gG cartridge fuse to EN 60269-2-1 or gN (Class J to UL 248-8 or Class C to UL 248-4)		
	Low voltage contact blocks	6 A type gL/gG cartridge fuse to EN 60269-2-1 or gN (Class J to UL 248-8 or Class C to UL 248-4)		
Electrical shock protection		Finger-safe conforming to IP2X		
		Mechanical Ratings		
Vibration (assembled to panel)		Tested at 10...2000 Hz, 1.52 mm displacement (peak-to-peak) max./10 G max. 6 hr		
Shock		Tested at 1/2 cycle sine wave for 11 ms and no damage at 100 G max.		
Contact durability per EN 60947-5-1 (Annex C)		10 000 000 cycles		
Contact operation	N.O.	Slow double make and break		
	N.C. & S.M.C.B.	Slow double make and break — positive opening ⊖		
	N.O.E.M.	Double break / double make, early make		
	N.C.L.B.	Double break / double make, late break — positive opening ⊖		
	N.C.E.B.	Double break / double make, early break — positive opening ⊖		
Push button travel to change electrical state	N.C. and N.O.E.M.	1.5 mm (0.060 in.)		
	N.O. and N.C.L.B.	2.5 mm (0.1 in.)		
Operating forces (typical)	Single circuit contact block	3.4 N		
	Dual circuit contact block	5...6.5 N		
		Illumination		
LED Dominant Wavelength	Green	525 nm		
	Red	629 nm		
	White	—		
LED Luminous Intensity	Green	780 mcd		
	Red	780 mcd		
	White	360 mcd		
Incandescent maximum wattage		2.6 W		
		Materials		
Springs		Stainless steel and zinc coated music wire		
Electrical contacts	Standard	Silver-nickel		
	Low voltage	Gold-plated over silver		
Terminals	Screw	Brass		
	Spring-clamp	Silver-plated brass		

★ Performance Data — see note on page 3.

‡ Low voltage contacts are recommended for applications below 17V, 5 mA.

§ Wires less than #18 AWG (0.75 mm²) may not hold in terminal securely.

Material Listing

Component	For Use with	Material Used
Panel gasket	All operators	Nitrile, TPE
Diaphragm seal	Illuminated push button, non-illuminated push button	Automotive industry acceptable silicone
K-seal	Selector switch, key selector switch, push/twist-to-release E-stop, key E-stop, push/pull mushroom	Nitrile
Diaphragm retainer, return spring I	Illuminated push button, non-illuminated push button, momentary mushroom	Stainless steel
Return spring II	Reset, selector switch, key selector switch, alternate action, push/twist-to-release E-stop, key E-stop, push/pull mushroom	Zinc-coated music wire
Button cap/mushroom head	Non-illuminated push button, momentary mushroom, reset, push/twist-to-release E-stop, key E-stop, push/pull mushroom, multi-function	PBT/polycarbonate blend
2-color molded button cap	Non-illuminated push button	PBT/polycarbonate blend
Lens	Multi-function	Acetal
Lens, knob	Illuminated push button, illuminated momentary mushroom, illuminated selector switch	Polyamide
Knob	Non-illuminated selector switch	Glass-filled polyamide
Plastic bezel/bushing I	Non-illuminated push button, illuminated push button, momentary mushroom, selector switch, key selector switch, push/twist-to-release E-stop, key E-stop, push/pull mushroom, multi-function, reset	Glass-filled polyamide
Plastic bezel/bushing II, jam nut	Pilot light, reset jam nut, reset pushers	Glass-filled PBT
Metal bezel/bushing	All metal operators	Zinc
Diffuser	Illuminated push button, pilot light	Polycarbonate
Legend frames	—	Glass-filled polyamide
Plastic mounting ring	All plastic operators	Glass-filled polyamide
Metal mounting ring	All metal operators	Chromated zinc
Plastic latch	—	Glass-filled polyamide
Metal latch	—	Chromated zinc + stainless steel
Plastic enclosure	—	PBT/polycarbonate blend
Metal enclosure	—	Aluminum
Terminal screws	LED module, incandescent module, contact blocks	Zinc-plated steel with chromate
Terminals	LED module, incandescent module, contact blocks	Brass with silver-nickel contacts
Spring clamps	LED module, incandescent module, contact blocks	Stainless steel
Lamp socket	Incandescent module	Brass
Housing	Incandescent module, LED module	Glass-filled polyamide
Low-voltage terminals	Contact blocks	Gold-plated silver-nickel contacts
Low-voltage spanner	Contact blocks	Gold-plated silver-nickel contacts
Spanner	Contact blocks	Brass with silver-nickel contacts
Boot	Toggle Switch, illuminated push button, non-illuminated push button, multi-function illuminated and non-illuminated	Automotive industry acceptable silicone

Momentary Push Button Operators, Non-Illuminated — Flush, Extended, Guarded



Flush Operator
Cat. No. 800FP-F3



Extended Operator
Cat. No. 800FM-E4



Guarded Operator
Cat. No. 800FP-G6

800F P - F 3 -
a b c d

a

Operator Construction	
Code	Description
P	Round plastic operator (IP66, Type 4/4X/13)
M	Round metal operator (IP66, Type 4/13)

b

Operator Type	
Code	Description
F	Flush
E	Extended
G	Guarded

c

Color Cap	
Code	Color
0	Orange
1	White
2	Black
3	Green
4	Red
5	Yellow
6	Blue
8	Grey★
9	No cap
X	Assortment pack‡

d

Packaging	
Code	Description
Blank	1 per package
BP	10 per package§

★ Available in flush only.

‡ Assortment pack contains one cap of each color, not available in BP packaging.

§ Only available with no color cap (9 from Table c).

Momentary Push Button Operators, Non-Illuminated — with Two-Color Molded Legend Caps



Flush Operator
Cat. No. 800FP-F301

800F P - F 3 01
 a *b* *c* *d*

a

Operator Construction	
Code	Description
P	Round plastic operator (IP66, Type 4/4X/13)
M	Round metal operator (IP66, Type 4/13)

b

Operator Type	
Code	Description
F	Flush
E	Extended
G	Guarded

c

Color Cap	
Code	Color
0	Orange
1	White
2	Black
3	Green
4	Red
5	Yellow
6	Blue

d

Legend Text*‡§	
Code	Text
Blank	No Text
01	START
02	STOP
05	O
06	I
08	→
09	Forward△
10	Reverse△
11	R

★ For custom laser-engraved legend cap, consult your local Rockwell Automation sales office or Allen-Bradley distributor.

‡ White and yellow caps have black text. All other color caps have white text.

♣ Legend button cap supplied loose for customer installation.

△ Available for flush only.

§ Valid color cap/legend text codes include:

Color	Text	
	Flush Caps	Extended Caps
White	FORWARD, REVERSE, START, I, →, R	→, R
Black	FORWARD, REVERSE, →, R	STOP, O, →, R
Green	FORWARD, REVERSE, START, I, →	→
Red	FORWARD, REVERSE, STOP, O, →	STOP, O, →
Yellow	FORWARD, REVERSE, →	→
Blue	FORWARD, REVERSE, →, R	→, R

Momentary Push Button Operators, Illuminated — Flush, Extended, Guarded



Flush Operator
Cat. No. 800FM-LF4



Extended Operator
Cat. No. 800FP-LE3



Guarded Operator
Cat. No. 800FP-LG3

800F P - LE 3 -
 a b c d

a

Operator Construction	
Code	Description
P	Round plastic operator (IP66, Type 4/4X/13)
M	Round metal operator (IP66, Type 4/13)

b

Operator Type	
Code	Description
LF	Flush
LE	Extended
LG	Guarded

c

Color Cap ★	
Code	Color
0	Amber‡
3	Green
4	Red
5	Yellow‡
6	Blue‡
7	Clear
9	No cap

d

Packaging	
Code	Description
Blank	1 per package
BP	10 per package§

★ For custom laser-engraved operator, consult your local Rockwell Automation sales office or Allen-Bradley distributor.

‡ When using LED for illumination, a white LED is recommended.

§ Only available with no color cap (9 from Table c).

Push-to-Test Push Button Device Schematic

Illuminated push buttons may be wired as a push-to-test device by using the following schematic and Cat. No. 800F-XD7 Diode module from page 10-111.

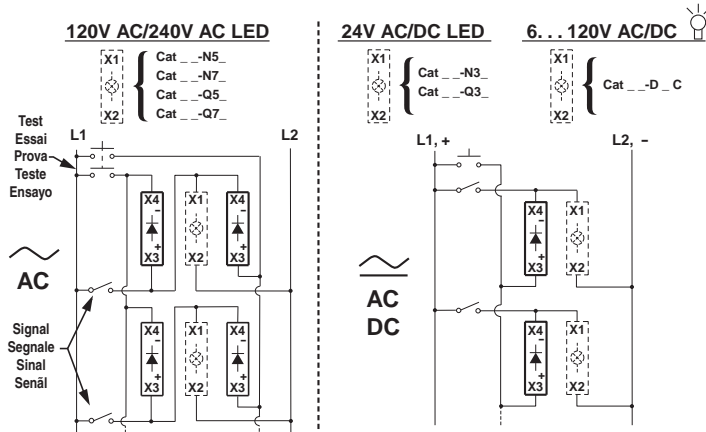

Alternate Action Operators — Non-Illuminated



Cat. No. 800FM-FA3

800F M - FA 3
 a b c

a

b

c

Operator Construction	
Code	Description
P	Round plastic operator (IP66, Type 4/4X/13)
M	Round metal operator (IP66, Type 4/13)

Operator Type*	
Code	Description
FA	Non-illuminated, flush, alternate action

Color Cap‡	
Code	Color
0	Orange
1	White
2	Black
3	Green
4	Red
5	Yellow
6	Blue
9	No cap
X	Assortment pack

* Must use N.O.E.M. or N.C. contacts.

‡ For custom laser-engraved legend cap, consult your local Rockwell Automation sales office or Allen-Bradley distributor.

Alternate Action Operators — Illuminated



Cat. No. 800FP-LFA3

800F P - LFA 3
 a b c

a

b

c

Operator Construction	
Code	Description
P	Round plastic operator (IP66, Type 4/4X/13)
M	Round metal operator (IP66, Type 4/13)

Operator Type*Δ	
Code	Description
LFA	Illuminated, flush, alternate action

Color Cap◆	
Code	Color
0	Amber◆
3	Green
4	Red
5	Yellow◆
6	Blue◆
7	Clear
9	No lens

* Must use N.O.E.M. or N.C. contacts.

Δ LED module required for illumination, can not use incandescent module.

◆ For custom laser-engraved operator, consult your local Rockwell Automation sales office or Allen-Bradley distributor.

◆ Use of a white LED is recommended.

Pilot Light Operators



Plastic Pilot Light
Cat. No. 800FP-P7



Metal Pilot Light
Cat. No. 800FM-P4

800F P - P 3 -
 a b c d

a

Operator Construction	
Code	Description
P	Round plastic operator (IP66, Type 4/4X/13)
M	Round metal operator (IP66, Type 4/13)

b

Operator Type	
Code	Description
P	Diffuser

c

Lens Cap★	
Code	Color
0	Amber‡
3	Green
4	Red
5	Yellow‡
6	Blue‡
7	Clear
9	No lens

d

Packaging	
Code	Description
Blank	1 per package
BP	10 per package

★ For custom laser-engraved pilot light, consult your local Rockwell Automation sales office or Allen-Bradley distributor.
 ‡ When using LED for illumination, a white LED is recommended.

2-Position Selector Switch Operators, Non-Illuminated



Standard Knob
Cat. No. 800FP-SM22



Knob Lever
Cat. No. 800FP-HM22

Switching Angle

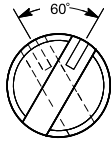

Target Table and Operator Position★		
Contact Type✦		
N.O.	O	X
N.C.	X	O

Note: X = Closed/O = Open

★ Target table for spring return from left is reversed from what is shown in the table.

✦ Contact selection is limited to the following options, consult your local Rockwell Automation sales office or Allen-Bradley distributor for other options.

800F P - S M2 2 -
 a b c d e f

a

Operator Construction	
Code	Description
P	Round plastic operator (IP66, Type 4/4X/13)
M	Round metal operator (IP66, Type 4/13)

b

Operator Type	
Code	Description
S	Standard knob
H	Knob lever‡

c

Operator Function	
Code	Type
M2	Maintained (60° switching angle)
L2	Spring return from left (60° switching angle)
R2	Spring return from right (60° switching angle)

d

Knob/Insert Color		
Code	Knob Color	Insert Color
2	Black	White

e

Orientation	
Code	Description
Blank	Standard
N	90° offset§

f

Packaging	
Code	Description
Blank	1 per package
BP	10 per package△

‡ 30 mm hole spacing will not work if knob lever is used. See page 38 for recommended operator panel spacing.

§ For use in vertical mount Bul. 800F enclosures.

△ Not available with 90° offset orientation.

2-Position Selector Switch Operators, Illuminated ✦



Standard Knob
Cat. No. 800FP-LSM26

Switching Angle



Target Table and Operator Position ✦		
Contact Type ✦		
N.O.	O	X
N.C.	X	O

Note: X = Closed/O = Open

✦ Target table for spring return from left is reversed from what is shown in the table.

✦ Contact selection is limited to the following options, consult your local Rockwell Automation sales office or Allen-Bradley distributor for other options.

800F P - LS M2 3
 a b c d e

a

Operator Construction	
Code	Description ‡
P	Round plastic operator (IP66, Type 4/4X/13)
M	Round metal operator (IP66, Type 4/13)

b

Operator Type	
Code	Description
LS	Standard knob
LH	Knob lever Δ

c

Operator Function	
Code	Type
M2	Maintained (60° switching angle)
L2	Spring return from left (60° switching angle)
R2	Spring return from right (60° switching angle)

d

Knob/Insert Color		
Code	Knob Color ✦	Insert Color
0	Amber ✦	White
3	Green	White
4	Red	White
5	Yellow ✦	Black
6	Blue ✦	White
7	Clear	Black

e

Orientation	
Code	Description
Blank	Standard
N	90° offset §

‡ LED module required for illumination, can not use incandescent module.

§ For use in vertical mount enclosures.

✦ Crevices may exist on product that may be unsuitable for certain applications. Please consult your local Rockwell Automation sales office or Allen-Bradley distributor.

Δ Only available in clear.

✦ Use of a white LED is recommended.

3-Position Selector Switch Operators, Non-Illuminated



Standard Knob
Cat. No. 800FP-SM32



Knob Lever
Cat. No. 800FM-HM32

Switching Angle

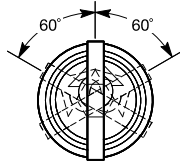

Target Table and Operator Position (60° Switching Angle)				
Contact Type ^Δ	Position on Mounting Latch			
N.O.	Left	X	O	O
	Right	O	O	X
	Center	X	O	X
	Center CL [§]	X	O	O
	Center CR [§]	O	O	X
N.C.	Left	O	X	X
	Right	X	X	O
	Center	O	X	O
	Center CL [§]	O	X	X
	Center CR [§]	X	X	O

Note: X = Closed/O = Open

^Δ Contact selection is limited to the following options, consult your local Rockwell Automation sales office or Allen-Bradley distributor for other options.

800F P - S M3 2

a *b* *c* *d* *e* *f*

a

Operator Construction	
Code	Description
P	Round plastic operator (IP66, Type 4/4X/13)
M	Round metal operator (IP66, Type 4/13)

b

Operator Type	
Code	Description
S	Standard knob
H	Knob lever★

c

Operator Function	
Code	Type
M3	Maintained
L3	Spring return from left
R3	Spring return from right
B3	Spring return from left and right

d

Knob/Insert Color		
Code	Knob Color	Insert Color
2	Black	White

e

Orientation	
Code	Description
Blank	Standard
N	90° offset [‡]

f

Operation	
Code	Description
Blank	Standard
CL	Center left [§]
CR	Center right [§]

★ 30 mm hole spacing will not work if knob lever is used. See page 38 for recommended operator panel spacing.

‡ For use in vertical mount enclosures.

§ The center contact block can have the same target output as the left or right contact block, by specifying center left (CL) or center right (CR) option.

3-Position Selector Switch Operators, Illuminated §



Standard Knob
Cat. No. 800FP-LSM37

Switching Angle

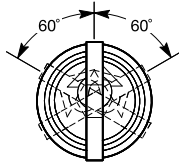

Target Table and Operator Position (60° Switching Angle)				
Contact Type ^Δ	Position on Mounting Latch			
N.O.	Left	X	O	O
	Right	O	O	X
N.C.	Left	O	X	X
	Right	X	X	O

Note: X = Closed/O = Open

^Δ Contact selection is limited to the following options, consult your local Rockwell Automation sales office or Allen-Bradley distributor for other options.

800F **P** - **LS** **M3** **3**
a *b* *c* *d* *e*

a

Operator Construction	
Code	Description★
P	Round plastic operator (IP66, Type 4/4X/13)
M	Round metal operator (IP66, Type 4/13)

b

Operator Type	
Code	Description
LS	Standard knob
LH	Knob lever♣

c

Operator Function	
Code	Type
M3	Maintained
L3	Spring return from left
R3	Spring return from right
B3	Spring return from left and right

d

Knob/Insert Color		
Code	Knob Color♦	Insert Color
0	Amber♦	White
3	Green	White
4	Red	White
5	Yellow♦	Black
6	Blue♦	White
7	Clear	Black

e

Orientation	
Code	Description
Blank	Standard
N	90° offset‡

- ★ LED module required for illumination, can not use incandescent module.
- ‡ For use in vertical mount 800F enclosures.
- § Crevices may exist on product that may be unsuitable for certain applications. Please consult your local Rockwell Automation sales office or Allen-Bradley distributor.
- ♣ Only available in clear.
- ♦ Use of a white LED is recommended.

4-Position Selector Switch Operators, Non-Illuminated



Standard Knob
Cat. No. 800FP-SM42

Target Table and Operator Position★					
Contact Type‡	Position on Mounting Latch				
N.O.	Left	O	O	X	O
	Right	X	O	O	O
	Center	X	O	X	O
	Center CL	O	O	X	O
	Center CR	X	O	O	O
N.C.E.B.	Left	O	O	O	X
	Right	O	X	O	O
	Center CL	O	O	O	X
	Center CR	O	X	O	O
N.C.L.B.	Left	X	X	O	X
	Right	O	X	X	X
	Center	O	X	O	X
	Center CL	X	X	O	X
	Center CR	O	X	X	X

Note: X = Closed/O = Open

★ Must use N.O., N.C.E.B., or N.C.L.B. contact blocks only. Cannot use N.C. or N.O.E.M. contact blocks with 4-position selector switch.

‡ Contact selection is limited to the following options, consult your local Rockwell Automation sales office or Allen-Bradley distributor for other options.

800F P - S M4 2

a b c d e f

a

Operator Construction	
Code	Description
P	Round plastic operator (IP66, Type 4/4X/13)
M	Round metal operator (IP66, Type 4/13)

c

Operator Function	
Code	Type
M4	Maintained (45° switching angle)

e

Orientation	
Code	Description
Blank	Standard
N	90° offset‡

b

Operator Type	
Code	Description
S	Standard knob
H	Knob lever

d

Knob/Insert Color		
Code	Knob Color	Insert Color
2	Black	White

f

Operation	
Code	Description
Blank	Standard
CL	Center left§
CR	Center right§

‡ For use in vertical mount enclosures.

§ The center contact block can have the same target output as the left or right contact block, by specifying center left (CL) or center right (CR) option.

2-Position Key-Operated Selector Switches, Non-Illuminated



Key Selector Switch
Cat. No. 800FP-KM21R

Switching Angle

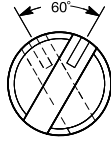

Target Table and Operator Position★		
Contact Type♦		
N.O.	O	X
N.C.	X	O

Note: X = Closed/O = Open

★ Target table for spring return from left is reversed from what is shown in the table.

♦ Contact selection is limited to the following options, consult your local Rockwell Automation sales office or Allen-Bradley distributor for other options.

800F M - KM2 1 d

a b c d

a

Operator Construction	
Code	Description
P	Round plastic operator (IP66, Type 4/13)
M	Round metal operator (IP66, Type 4/13)

b

Operator Type	
Code	Type
KM2	Maintained (60° switching angle)
KL2	Spring return from left (60° switching angle)
KR2	Spring return from right (60° switching angle)

c

Key Removal Position‡	
Code	Position
1	Left
2	Right
3	Both

d

Ronis Key Lock§*Δ	
Code	Key No.
Blank	3825 (Standard)
R	455
01R	3801
02R	3802
03R	3803
04R	3804
05R	3805
06R	3806
27R	4001
28R	4002
29R	4003
30R	4004
31R	4005
32R	4006
33R	4007

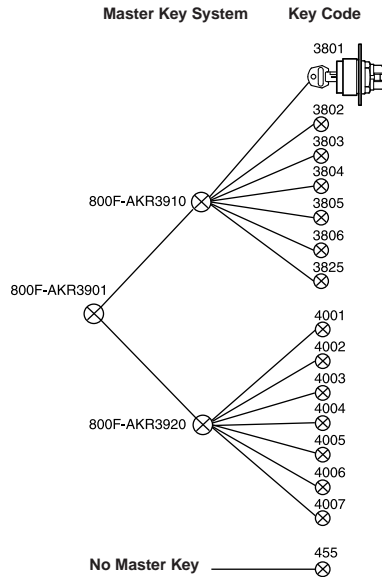

‡ Key removal in maintained positions only.

§ Keyed operators are IP66, Type 4/13.

* Not intended for high security applications. Interoperability is possible with certain key/cylinder lock combinations. Consult your local Rockwell Automation sales office or Allen-Bradley distributor for interoperability information.

Δ For replacement Ronis keys, see Accessories, consult your local Rockwell Automation sales office or Allen-Bradley distributor.

3-Position Key-Operated Selector Switches, Non-Illuminated



Key-Operated Selector Switch
Cat. No. 800FP-KM31R



Key-Operated Selector Switch
Cat. No. 800FM-KM31R

Switching Angle

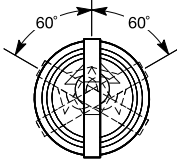

Target Table and Operator Position				
Contact Type ♦	Position on Mounting Latch			
N.O.	Left	X	O	O
	Right	O	O	X
	Center	X	O	X
N.C.	Left	O	X	X
	Right	X	X	O
	Center	O	X	O

Note: X = Closed/O = Open

♦ Contact selection is limited to the following options, consult your local Rockwell Automation sales office or Allen-Bradley distributor for other options.

800F - KM3

a b c d

a

Operator Construction	
Code	Description
P	Round plastic operator (IP66, Type 4/13)
M	Round metal operator (IP66, Type 4/13)

b

Operator Type	
Code	Description
KM3	Maintained
KR3	Spring return from right
KL3	Spring return from left
KB3	Spring return from both

c

Key Removal Position ★		
Code	Type	
1	Left	
3	All	
4	Center	
5	Left/center	
7Δ	Center/right	

d

See page 16 for optional key codes ‡§♣

★ Key removal in maintained positions only.

‡ Keyed operators are IP66, Type 4/13.

§ Not intended for high security applications. Interoperability is possible with certain key/cylinder lock combinations. Consult your local Rockwell Automation sales office or Allen-Bradley distributor for interoperability information.

♣ For replacement Ronis keys, consult your local Rockwell Automation sales office or Allen-Bradley distributor.

Δ Key removal position only valid with operator types 800F_-KM3 and 800F_-KL3.

2-Position Push-Pull Operators, Non-Illuminated — Twist-to-Release (Trigger Action), Push-Pull (Trigger Action)★▲



40 mm Trigger Action
Twist-to-Release Mushroom
Cat. No. 800FP-MT44



40 mm Trigger Action
Push-Pull Mushroom
Cat. No. 800FP-MP44

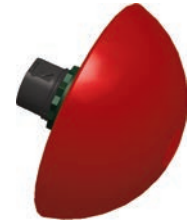

90 mm Half-Dome
Cat. No. 800FP-MP94

800F P – MT4 4

a *b* *c* *d*

a

Operator Construction	
Code	Description
P	Round plastic operator (IP66, Type 4/4X/13)
M	Round metal operator (IP66, Type 4/13)

b

Operator Type	
Push, Twist-to-Release◆	
Code	Type
MT3	30 mm color cap
MT4	40 mm color cap
MT6	60 mm color cap
Push-Pull▽	
Code	Type
MP4	40 mm color cap
Half-Dome Push-Pull▽	
Code	Type
MP9	90 mm color cap‡

c

Color Cap	
Code	Color
2	Black
3	Green
4	Red
5	Yellow
6	Blue

d§▲

Engraving	
Code	Description
Blank	No engraving on cap
LE	EMO laser engraved
E	EMO printed

- ★ All emergency stop operators are EN ISO 13850 compliant with standard NC, NCLB, or self-monitoring contact blocks.
- ▲ E-Stop operators, latch, and contact block combinations have been third-party tested for B10d values. B10d values can be found in publication SAFETY-SR001_-EN-E.
- ◆ Only available with red color cap.
- § For EMO guards, consult your local Rockwell Automation sales office or Allen-Bradley distributor.
- ▲ Only available on 40 mm color cap.
- △ Only available on red, 40 mm push, twist-to-release operator type (MT44).
- ‡ Half-dome operators only available with black, red, and yellow color caps.
- ▽ Limit of four contact blocks max. for these devices.

2-Position Push-Pull Operators, Illuminated — Twist-to-Release (Trigger Action), Push-Pull (Trigger Action)★‡∇



40 mm Illuminated Twist-to-Release
Cat. No. 800FP-LMT44



40 mm Mushroom Push/Pull
Cat. No. 800FM-LMP44

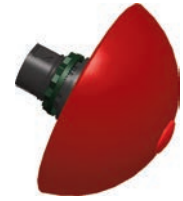

90 mm Half-Dome
Cat. No. 800FP-LMP94

800F P - LMP4 3
a b c

a

Operator Construction	
Code	Description
P	Round plastic operator (IP66, Type 4/4X/13)
M	Round metal operator (IP66, Type 4/13)

b

Operator Type	
Push, Twist-to-Release§♣	
Code	Type
LMT4	40 mm color cap
LMT6	60 mm color cap
Push-Pull&	
Code	Type
LMP3	30 mm color cap
LMP4	40 mm color cap
LMP6	60 mm color cap
Half-Dome Push-Pull&	
Code	Type
LMP9	90 mm color cap♠

c

Lens Cap Color	
Code	Color
3	Green
4	Red
5	Yellow♦
6	Blue△♦

★ LED module required for illumination, can not use incandescent module.

‡ All emergency stop operators are EN ISO 13850 compliant with standard NC, NCLB, or self-monitoring contact blocks.

∇ E-Stop operators, latch, and contact block combinations have been third-party tested for B10d values. B10d values can be found in publication SAFETY-SR001_-EN-E.

§ Only available with red color cap.

♣ 60 mm version has black arrows; 30 and 40 mm versions have white arrows.

♦ Use of a white LED is recommended.

△ Only available with 40 mm Push-Pull color cap (LMP4 from Table b).

♠ Half-dome operators only available with red and yellow lens cap colors.

& Limit of four contact blocks max. for these devices.

2-Position Non-Illuminated Operators — Mushroom, Key Release (Trigger Action)★△



40 mm Key Release Mushroom
Cat. No. 800FP-MK44

800F P - MK4 4
 a b c d

a

Operator Construction	
Code	Description
P	Round plastic operator (IP66, Type 4/13)
M	Round metal operator (IP66, Type 4/13)

b

Operator Type	
Key Release Mushroom	
Code	Type
MK4	40 mm

c

Lens Cap Color	
Code	Color
4	Red

d

Ronis Key Lock†§*	
Code	Key No.
Blank	3825 (Standard)
R	455
01R	3801
02R	3802
03R	3803
04R	3804
05R	3805
06R	3806
27R	4001
28R	4002
29R	4003
30R	4004
31R	4005
32R	4006
33R	4007

- ★ All emergency stop operators are EN ISO 13850 compliant with standard NC, NCLB, or self-monitoring contact blocks.
- △ E-Stop operators, latch, and contact block combinations have been third-party tested for B10d values. B10d values can be found in publication SAFETY-SR001_-EN-E.
- † Keyed operators are IP66, Type 4/13.
- § Not intended for high security applications. Interoperability is possible with certain key/cylinder lock combinations. Consult your local Rockwell Automation sales office or Allen-Bradley distributor for interoperability information.
- * For replacement Ronis keys, consult your local Rockwell Automation sales office or Allen-Bradley distributor.

3-Position Push-Pull Operators, Illuminated & Non-Illuminated — Mushroom Δ



Illuminated 3-Position Push-Pull
Cat. No. 800FM-LMP44E3

Target Table and Operator Position \star			
Contact Type ∇			
	Out	Center	In
N.O.	O	O	X
N.C.E.B.	X	O	O
N.C.L.B.	X	X	O

Note: X = Closed/O = Open

\star Must use N.O., N.C.E.B., or N.C.L.B. contact blocks only. Cannot use N.C. or N.O.E.M. contact blocks with 3-position push-pull operators.

∇ Contact selection is limited to the following options, consult your local Rockwell Automation sales office or Allen-Bradley distributor for other options.

800F **M** – **L** **MM** **4** **4** **E3**
a *b* *c* *d* *e* *f*

a

Operator Construction	
Code	Description
M	Round metal operator (IP66, Type 4/13)

b

Operator Type	
Code	Description
Blank	Non-illuminated
L	Illuminated \ddagger

c

Operator Function	
Code	Description
MM	Momentary out, Maintained center, Momentary in
MP	Momentary out, Maintained center, Maintained in

d

Cap Size	
Code	Description
4	40 mm plastic

e

Cap Color	
Code	Description
0	Amber \S \clubsuit
2	Black \clubsuit
3	Green
4	Red
6	Blue \S \clubsuit
7	Clear \S \clubsuit

f

Positions	
Code	Description
E3	3-position

Δ Sold as stand-alone operator only. Not available as a composite catalog number.

\ddagger LED module required for illumination. Cannot use incandescent module.

\S Available in illuminated only.

\clubsuit Use of white LED is recommended.

\clubsuit Available in non-illuminated only.

Momentary Push Button Operators, Non-Illuminated — Mushroom ★



40 mm Mushroom
Cat. No. 800FM-MM42



60 mm Mushroom
Cat. No. 800FP-MM63



90 mm Mushroom
Cat. No. 800FP-MM94

800F P - MM4 3
 a b c

a

Operator Construction	
Code	Description
P	Round plastic operator (IP65, Type 4/4X/13)
M	Round metal operator (IP65, Type 4/13)

b

Size and Operator Type	
Code	Type
MM4	40 mm momentary
MM6	60 mm momentary
MM9	90 mm momentary‡

c

Color Cap	
Code	Color
2	Black
3	Green
4	Red
5	Yellow
6	Blue

★ Momentary mushroom operators are IP65 rated.
 ‡ Only available with black, red, and yellow cap colors.

Momentary Push Button Operators, Illuminated — Mushroom Δ



40 mm Mushroom
Cat. No. 800FP-LMM43

800F P - LMM4 3
 a b c

a

Operator Construction	
Code	Description
P	Round plastic operator (IP65, Type 4/4X/13)
M	Round metal operator (IP65, Type 4/13)

b

Size and Operator Type	
Code	Type
LMM4	40 mm momentary

c

Lens Cap Color	
Code	Color
3	Green
4	Red
5	Yellow§
6	Blue §
7	Clear §

Δ Momentary mushroom operators are IP65 rated.
 § When using LED for illumination, a white LED is recommended.

2-Function Momentary Multi-Operator, Non-Illuminated



2-Function Momentary Multi-Operator Non-Illuminated
Cat. No. 800FP-U2E4F3

800F P – U2 E 4 F 3 (with button caps)
a b c d e f

800F P – U2 X (without button caps)
a b c

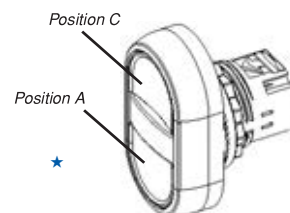

a

Operator Construction	
Code	Description
P	Plastic operator (IP66, Type 4/4X)
M	Metal operator (IP66, Type 4)

b

Operator Type	
Code	Description
U2	Two-function

c

Operator Type — Position A★	
Code	Description
F	Flush
E	Extended
X	No caps (all positions)‡

d

Operator Color Cap/Text — Position A§	
Code	Description
1	White
2	Black
3	Green
4	Red
5	Yellow
6	Blue
A	Green with “Start” text
B	Red with “Stop” text
C	White with “Start” text
D	Black with “Stop” text
E	Green with “I” text
F	Red with “O” text
G	White with “I” text
H	Black with “O” text

e

Operator Type — Position C★	
Code	Description
F	Flush
E	Extended

f

Operator Color Cap/Text — Position C§	
Code	Description
1	White
2	Black
3	Green
4	Red
5	Yellow
6	Blue
A	Green with “Start” text
B	Red with “Stop” text
C	White with “Start” text
D	Black with “Stop” text
E	Green with “I” text
F	Red with “O” text
G	White with “I” text
H	Black with “O” text

★ Position 1 of the latch (left position when viewed from the back) corresponds to position A of the operator. Position 2 of the latch (right position when viewed from the back) corresponds to position C of the operator.

‡ For custom-engraved caps, consult your local Rockwell Automation sales office or Allen-Bradley distributor.

§ Valid color cap/legend text codes include:

Color	Text	
	Flush Caps	Extended Caps
White	START, I	—
Black	—	STOP, O
Green	START, I	—
Red	—	STOP, O

2-Function Momentary Multi-Operator, Illuminated★



2-Function Momentary Multi-Operator Illuminated
Cat. No. 800FP-LU2E2E1

800F P – LU2 E 4 F 3 (with button caps)
a b c d e f

800F P – LU2 X (without button caps)
a b c

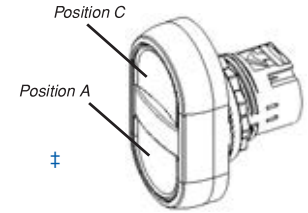

a

Operator Construction	
Code	Description
P	Plastic operator (IP66, Type 4/4X)
M	Metal operator (IP66, Type 4)

b

Operator Type★	
Code	Description
LU2	Two-function Illuminated

c

Operator Type — Position A‡	
Code	Description
F	Flush
E	Extended
X	No caps (all positions)§

d

Operator Color Cap/Text — Position A*	
Code	Description
1	White
2	Black
3	Green
4	Red
5	Yellow
6	Blue
A	Green with "Start" text
B	Red with "Stop" text
C	White with "Start" text
D	Black with "Stop" text
E	Green with "I" text
F	Red with "O" text
G	White with "I" text
H	Black with "O" text

f

Operator Color Cap/Text — Position C*	
Code	Description
1	White
2	Black
3	Green
4	Red
5	Yellow
6	Blue
A	Green with "Start" text
B	Red with "Stop" text
C	White with "Start" text
D	Black with "Stop" text
E	Green with "I" text
F	Red with "O" text
G	White with "I" text
H	Black with "O" text

e

Operator Type — Position C‡	
Code	Description
F	Flush
E	Extended

★ LED module required for illumination, can not use incandescent module.

‡ Position 1 of the latch (left position when viewed from the back) corresponds to position A of the operator. Position 2 of the latch (right position when viewed from the back) corresponds to position C of the operator. Position 3 of the latch (center position) is reserved for the power module.

§ For custom-engraved caps, consult your local Rockwell Automation sales office or Allen-Bradley distributor.

* Valid color cap/legend text codes include:

Color	Text	
	Flush Caps	Extended Caps
White	START, I	—
Black	—	STOP, O
Green	START, I	—
Red	—	STOP, O

3-Function Momentary Multi-Operator, Non-Illuminated



3-Function Momentary Multi-Operator Non-Illuminated
Cat. No. 800FP-U3E4F34

800F P – U3 E 4 F 3 4 (with button caps)
a b c d e f g

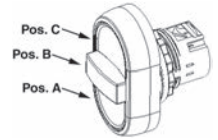

800F P – U3 X (without button caps)
a b c

a

Operator Construction	
Code	Description
P	Plastic operator (IP66, Type 4/4X)
M	Metal operator (IP66, Type 4)

b

Operator Type	
Code	Description
U3	Three-function

c

Operator Type — Position A*	
Code	Description
F	Flush
E	Extended
X	No caps (all positions)‡§

d

Operator Color Cap/Text — Position A*	
Code	Description
1	White
2	Black
3	Green
4	Red
5	Yellow
6	Blue

d (cont'd)

Operator Color Cap/Text — Position A*	
Code	Description
A	Green with “Start” text
B	Red with “Stop” text
C	White with “Start” text
D	Black with “Stop” text
E	Green with “I” text
F	Red with “O” text
G	White with “I” text
H	Black with “O” text

e

Operator Type — Position C*	
Code	Description
F	Flush
E	Extended

f

Operator Color Cap/Text — Position C*	
Code	Description
1	White
2	Black
3	Green
4	Red
5	Yellow
6	Blue

f (cont'd)

Operator Color Cap/Text — Position C*	
Code	Description
A	Green with “Start” text
B	Red with “Stop” text
C	White with “Start” text
D	Black with “Stop” text
E	Green with “I” text
F	Red with “O” text
G	White with “I” text
H	Black with “O” text

g

Operator Color Cap/Text — Position B*§	
Code	Description
4	Red
B	Red with “Stop” text
F	Red with “O” text

* Position 1 of the latch (left position when viewed from the back) corresponds to position A of the operator. Position 2 of the latch (right position when viewed from the back) corresponds to position C of the operator. Position 3 of the latch (center position) corresponds to position B of the operator.

‡ For custom-engraved caps, consult your local Rockwell Automation sales office or Allen-Bradley distributor.

§ For “no caps” option, (position B) center cap available as red, no text only.

* Valid color cap/legend text codes include:

Color	Text	
	Flush Caps	Extended Caps
White	START, I	—
Black	—	STOP, O
Green	START, I	—
Red	—	STOP, O

Reset Operators — Mechanical and/or Electrical Reset



Reset Operator
Cat. No. 800FP-R611

800F M - R 6 11
 a *b* *c* *d*

a

Operator Construction	
Code	Description
P	Round plastic operator (IP66, Type 4/4X/13)
M	Round metal operator (IP66, Type 4/13)

b

Operator Type	
Code	Type
R	Reset *‡

c

Color Cap	
Code	Color
1	White
2	Black
6	Blue

d

Legend Text	
Code	Text
Blank	No text
11	R

* Will accept latch and up to four single circuit contact blocks or two dual circuit contact blocks; no contacts allowed in center position.

‡ 11 mm reset stroke length.

Selector Push Button Operators



Selector Jog Operator
Cat. No. 800FM-SJ23

Target Table and Operator Position (2-Position)

Contact Type†	Position on Mounting Latch	⤵		⤴	
		Selector Left Free	Selector Left Depressed	Selector Right Free	Selector Right Depressed
N.O.	Left	O	X	O	O
N.O.	Right	O	O	O	X
N.O.	Center	O	X	O	X
N.C.	Left	X	O	X	X
N.C.	Right	X	X	X	O
N.C.	Center	X	O	X	O

Note: X = Closed/O = Open

Target Table and Operator Position (3-Position)

Contact Type†	Position on Mounting Latch	⤵		⤴		⤶	
		Selector Left Free	Selector Left Depressed	Selector Center Free	Selector Center Depressed	Selector Right Free	Selector Right Depressed
N.O.	Left	O	X	O	X	O	O
N.O.	Right	O	O	O	X	O	X
N.O.	Center	O	X	O	X	O	X
N.C.	Left	X	O	X	O	X	X
N.C.	Right	X	X	X	O	X	O
N.C.	Center	X	O	X	O	X	O

Note: X = Closed/O = Open

† Contact selection is limited to the following options; consult your local Rockwell Automation sales office or Allen-Bradley distributor for other options.

800F P - SJ 2 2
a b c d

a

Operator Construction	
Code	Description
P	Round plastic operator (IP66, Type 4/4X/13)
M	Round metal operator (IP66, Type 4/13)

c

Operator Function	
Code	Description
2	2-position
3	3-position

b

Operator Type	
Code	Description
SJ	Selector jog

d

Color Cap★	
Code	Description
2	Black
3	Green

★ Buttons cannot be engraved.

Toggle Switch Operators



Toggle Switch Operator
Cat. No. 800FM-JM2

Target Table and Operator Position (2-Position)

Contact Type*	Position on Mounting Latch			
		Toggle Left	Center	Toggle Right
N.O.	Left	O	O	X
N.O.	Right	X	O	O
N.O.	Center	X	O	X
N.C.	Left	X	X	O
N.C.	Right	O	X	X
N.C.	Center	O	X	O

Note: X = Closed/O = Open

Target Table and Operator Position (4-Position)§

Contact Type*	Position on Mounting Latch					
		Toggle Up	Toggle Left	Center	Toggle Right	Toggle Down
N.O.	Left	X	O	O	O	O
N.O.	Right	O	X	O	O	O
N.O.	Center	X	X	O	O	O
N.C.L.B.	Left	O	X	X	X	X
N.C.L.B.	Right	X	O	X	X	X
N.C.L.B.	Center	O	O	X	X	X
N.C.E.B.	Left	O	O	O	O	X
N.C.E.B.	Right	O	O	O	X	O

Note: X = Closed/O = Open

* Contact selection is limited to the following options, consult your local Rockwell Automation sales office or Allen-Bradley distributor for other options.

§ Must use N.O., N.C.E.B., or N.C.L.B. contact blocks only. Cannot use N.C. or N.O.E.M. contact blocks with 4-position toggle switch.

800F M - J M2
 a b c

a

b

c

Operator Construction	
Code	Description
M	Round metal operator (IP66, Type 4/13)

Operator Type	
Code	Description
J	Toggle switch *‡

Operator Function	
Code	Description
M2	2-position, maintained
R2	2-position, momentary
M4	4-position, maintained
R4	4-position, momentary

* Use legend plates 800F-34_ and 800F-35_.

‡ Silicone boot comes standard with toggle switch, consult your local Rockwell Automation sales office or Allen-Bradley distributor for replacement boots.

Back-of-Panel Components

Contact Blocks with Latch — Composite

800F – P X 0 1 E
a *b* *c* *d* *e*



a

Style	
Code	Description
P	Plastic latch
M	Metal latch

c

N.O. (Normally Open) Circuits	
Code	Description
0	No contact
1	1 N.O.
2	2 N.O.
3	3 N.O.
4	4 N.O.
5	5 N.O.
6	6 N.O.

d

N.C. (Normally Closed) Circuits	
Code	Description
0	No contact
1	1 N.C.
2	2 N.C.
3	3 N.C.
4	4 N.C.
5	5 N.C.
6	6 N.C.

b

Contact Block(s) Termination Style*	
Code	Description
X	Screw termination
Q	Spring-clamp termination

e

Specialty Contact Block(s)	
Code	Description
Blank	Standard blocks
V	Low voltage — QuadCONNECT™
E	N.O. early make
L	N.C. late break
B	N.C. early break
S	N.C. self-monitoring

* Six circuits maximum allowable.

Power Modules with Latch — Composite

800F – M N 3 G
a *b* *c* *d*



a

Style	
Code	Description
P	Plastic latch
M	Metal latch

c

Voltage	
Code	Description
0	No bulb Δ
1	6V AC/DC Δ
2	12V AC/DC Δ
3	24V AC/DC
4	48V AC/DC Δ
5	120V AC
7	240V AC \blacklozenge

d

Lamp Color \blacklozenge	
Code	Description
C	Incandescent
R	Red LED
G	Green LED
W	White LED

b

Power Module Type \S \clubsuit	
Code	Description
D	Incandescent module, screw termination
N	Integrated LED module, screw termination
Q	Integrated LED module, spring-clamp termination

\S LED modules for use with all illuminated operators. Incandescent module for use with pilot lights, momentary push buttons, and momentary mushroom operators only.

\clubsuit Four circuits maximum allowable when power module is used. Contact blocks cannot be stacked on power module.

Δ Only available for incandescent module.

\blacklozenge Only available for integrated LED module.

\blacklozenge For best illumination results, LED color should match lens color. For yellow operator, select a white LED.

Back-of-Panel Components, Continued

Power Modules with Contact Blocks and Latch — Composite

800F – P N 5 R X 1 0 E
a *b* *c* *d* *e* *f* *g* *h*

a

Style	
Code	Description
P	Plastic latch
M	Metal latch

b

Power Module Type*‡	
Code	Description
D	Incandescent module, screw termination
N	Integrated LED module, screw termination
Q	Integrated LED module, spring-clamp termination

c

Voltage	
Code	Description
0	No bulb§
1	6V AC/DC§
2	12V AC/DC§
3	24V AC/DC
4	48V AC/DC§
5	120V AC
7	240V AC♣

d

Lamp Color△	
Code	Description
C	Incandescent
R	Red LED
G	Green LED
W	White LED

e

Contact Block(s) Termination Style	
Code	Description
X	Screw termination
Q	Spring-clamp termination

f

N.O. (Normally Open) Circuits	
Code	Description
0	No contact
1	1 N.O.
2	2 N.O.
3	3 N.O.
4	4 N.O.

g

N.C. (Normally Closed) Circuits	
Code	Description
0	No contact
1	1 N.C.
2	2 N.C.
3	3 N.C.
4	4 N.C.

h

Specialty Contact Block(s)	
Code	Description
Blank	Standard blocks
V	Low voltage — QuadCONNECT™
E	N.O. early make
L	N.C. late break
B	N.C. early break
S	N.C. self-monitoring

★ Four circuits maximum allowable when power module is used. Contact blocks cannot be stacked on power module.
 ‡ LED modules for use with all illuminated operators. Incandescent module for use with pilot lights, push buttons, and momentary mushroom operators only.
 § Only available for incandescent module.
 ♣ Only available for integrated LED module.
 △ For best illuminated results, LED should match lens color. For yellow operator, select a white LED.

Assembled Stations with DeviceNet

2-Hole

800F –

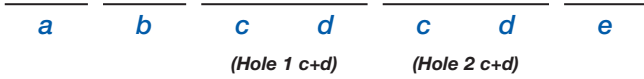

3-Hole

800F –

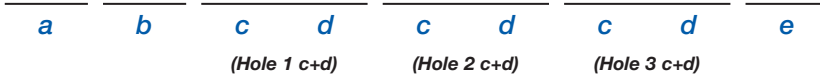

4-Hole

800F –

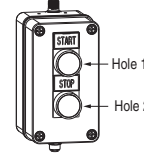
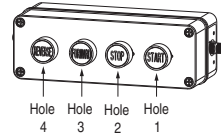
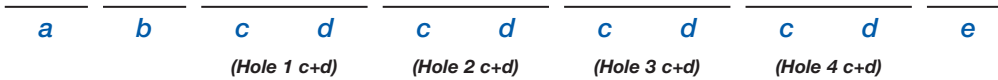

4-Hole Assembled Station
Cat. No. 800F-VHA3A4J3J4J

a

Mounting Orientation	
Code	Description
V	Vertical ★
H	Horizontal

b

Enclosure Style/Legends	
Code	Description
A	2-hole/legend frames
B	3-hole/legend frames
C	4-hole/legend frames
D	2-hole/no legend frames
E	3-hole/no legend frames
F	4-hole/no legend frames
H	2-hole/E-stop only no legend frames ‡

c

Operator Types	
Code	Description
A	Non-illuminated flush button
B	Non-illuminated extended button
C	Non-illuminated guarded button
D	Illuminated flush button ▽
E	Illuminated extended button ▽
F	Illuminated guarded button ▽
G	Non-illuminated 2-pos. selector switch
H	Non-illuminated 3-pos. selector switch
J	Pilot light (diffused)
K	Hole plug &
L	Non-illuminated TTR E-stop §&
M	Non-illuminated push pull §&
N	2-pos. key selector switch
P	3-pos. key selector switch
R	Non-illuminated 40 mm mushroom
T	E-stop key release §&
U	Potentiometer *&
W	Illuminated push pull
X	Illuminated 2-pos. maintained selector switch
Y	Illuminated 3-pos. maintained selector switch
Z	Illuminated 40 mm mushroom

d

Color/Text	
Code	Description
1	White
2	Black
3	Green
4	Red
5	Yellow
6	Blue
7	Clear
8	Grey Δ
9	No cap
0	Amber
A	Green with "Start" text
B	Red with "Stop" text
C	Black with "→" symbol
D	Black with "←" symbol
E	Black with "↑" symbol
F	Black with "↓" symbol
G	Green with "I" symbol
H	Red with "O" symbol
L	Blue with "R" text
M	Red with yellow metal guard #
N	Yellow with yellow metal guard #

e

External I/O Version ♦	
Code	Description
Blank	No external I/O
A	1 input/1 output (sinking)
B	1 input/1 output (sourcing)
C	2 input
E	2 output (sourcing)
F	1 E-stop block ♣
G	2 E-stop block ♣
H	2 input/2 output
K	2 input/2 output (sourcing)
L	1 input/1 output (sinking) + 1 E-stop block ♣
M	1 input/1 output (sourcing) + 1 E-stop block ♣
N	1 input/1 output (sinking) + 2 E-stop block ♣
P	1 input/1 output (sourcing) + 2 E-stop block ♣
Q	2 input + 1 E-stop block ♣
R	2 input + 2 E-stop block ♣
U	2 output (sourcing) + 1 E-stop block ♣
W	2 output (sourcing) + 2 E-stop block ♣
X	2 input + 1 input/1 output (sinking)

★ Selector Switches in a vertical mount enclosure are mounted with a horizontal orientation.
 ‡ Enclosure Style/Legend option H from Table b can only select one operator from Table c. Valid options are L, M, and T. Also see footnote §
 § Operator Types L, M, and T from Table c may be used as emergency stops. To be valid as an E-Stop, operators must use color/text option 4 from Table d and it must be placed in the last hole position in the enclosure, where a yellow round E-stop legend plate is provided. An E-Stop connector also must be chosen from Table e. Also see footnote ♣
 ♣ Potentiometer allowed in first hole position only.
 Δ Available in flush only.
 ♦ This is an 8-in/4-out device. 2-in and 1-out are assigned to each hole position in the enclosure. If a 2-hole enclosure is selected, 4-in and 2-out are assigned internally and up to 4 unassigned I/O points can be assigned to external connectors. This device contains up to two physical external I/O connectors. The "+" symbol in the Description field of table e indicates that two external connectors exist. If an E-Stop connector is used, 2 unassigned I/O points can be assigned to the other connector.
 ♣ External I/O Versions F, L, M, Q, and U receive only one contact block for the external E-Stop string. These connectors are rated 3 A. If more than 3 A of current is needed or if there are two E-Stop strings, use External I/O Versions G, N, P, R, and W. These versions receive two contact blocks. This allows for 6 A of switching or for two E-Stop strings.
 ▽ Cannot be ordered with "No Cap" (9 from Table d - Color/Text).
 & Operator Types K, L, M, T, and U from Table c are not available with legend frames.
 # Only available with non-illuminated push-pull operator (M from Table c).

Two-Color Molded Legend Caps — Non-Illuminated Push Buttons

800F – AF 3 01
a *b* *c*



Cat. No. 800F-15YSE112C

Button Cap Type	
Code	Description
AF	Flush
AE	Extended

Color Cap	
Code	Description
1	White
2	Black
3	Green
4	Red
5	Yellow
6	Blue

Legend Text‡§	
English	
Code	Description
01	START
02	STOP
05	O
06	I
08	→
09	FORWARD★
10	REVERSE★
11	R

- ★ Available in flush only.
- ‡ White and yellow caps have black text. All other color caps have white text.
- § Valid color cap text codes include:

Color	Text	
	Flush Caps	Extended Caps
White	FORWARD, REVERSE, START, I, →, R	→, R
Black	FORWARD, REVERSE, →, R	STOP, O, →, R
Green	FORWARD, REVERSE, START, I, →	→
Red	FORWARD, REVERSE, STOP, O, →	STOP, O, →
Yellow	FORWARD, REVERSE, →	→
Blue	FORWARD, REVERSE, →, R	→, R

Emergency Stop Legend Plates ♣

800F – 15YS
a *b*

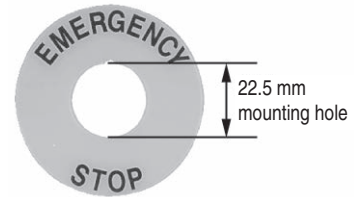

Size/Color (Yellow)	
Code	Description
15Y	60 mm round (30.5 mm mounting hole)
15YS	60 mm round (22.5 mm mounting hole)♦
16Y	90 mm round (22.5 mm mounting hole)♦

Text	
Code	Description
Blank	No text
E112	EMERGENCY STOP
F112	ARRÊT D'URGENCE▲
S112	PARO DE EMERGENCIA
G112	NOT HALT
T112	ARRESTO EMERGENZA
N112	NÖDSTOPP, EMERGENCY STOP▲
P112	PARADA DE EMERGENCIA

Text	
Code	Description
W112	NÖDSTOPP, EMERGENCY STOP▲
A112	NÖDSTOP
B112	EMERGENCY STOP, ARRÊT D'URGENCE, PARADA DE EMERGENCIA▲
D112	NOODSTOP▲
M112	NOT HALT, ARRESTO EMERGENZA, ARRÊT D'URGENCE▽
L112	NEYÐARSTOPP, NEYÐARSTOPP▲
H112	NÖD-STOP, HÄTÄ-SEIS, NÖD-STOP▲

- ♣ Sold only multiples of 10. Order (quantity of) 10 to receive one package of 10 pieces.
- ♦ Not for use with base mounted contact blocks.
- ▲ Not available on 15YS version.
- ▽ Text printed on the 15Y version only.
- & Text printed on the 15YS & 16Y versions only.

Push Button, Multi-Function Caps

800F – A F 1 C
a *b*

Type	
Code	Description
E	Push button extended cap
F	Push button flush cap
FA	Alternate action cap
FAU	Multi-function flush cap (for position A)
EAU	Multi-function extended cap (for position A)
FCU	Multi-function flush cap (for position C)
ECU	Multi-function extended cap (for position C)

Color	
Code	Description
0	Amber
1	White
2	Black
3	Green
4	Red
5	Yellow
6	Blue

Approximate Dimensions

Dimensions in millimeters. Dimensions are not intended to be used for manufacturing purposes. Refer to RAISE software for additional dimensional information.

Non-Illuminated and Illuminated Momentary Flush Push Button Operators

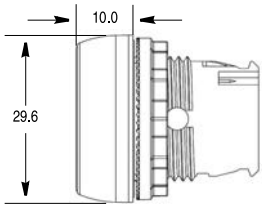

Illuminated Momentary Guarded Push Button Operators

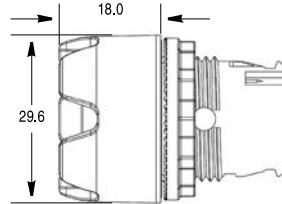

Illuminated and Non-Illuminated Momentary Extended Push Button Operators

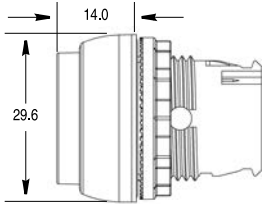

Reset Operators with Reset Rod

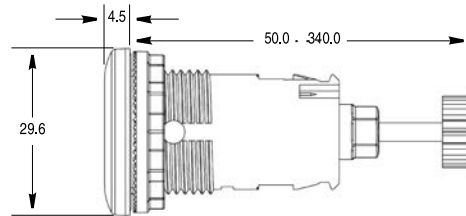

Non-Illuminated Guarded, Illuminated and Non-Illuminated Alternate Action Push Button Operators

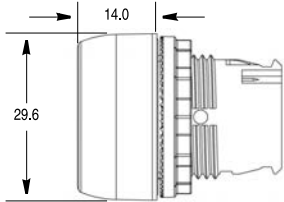

Pilot Light Operators

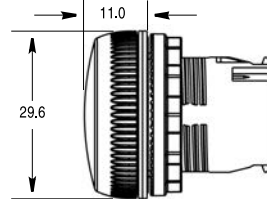

90 mm Half Dome

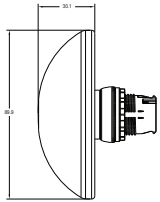

90 mm Mushroom

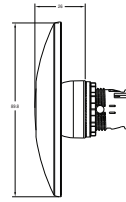

Illuminated and Non-Illuminated Momentary Mushroom Operators 40 mm and 60 mm

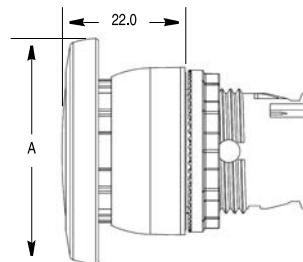

Operator	A
40 mm	39.8
60 mm	59.8

Toggle Switch Operators

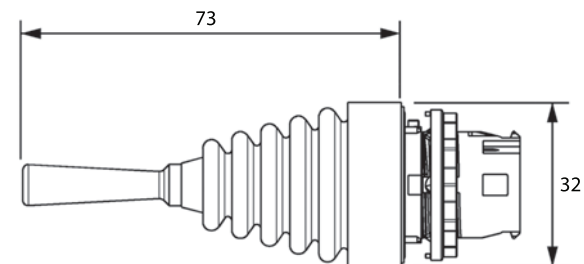

Selector Jog Operators

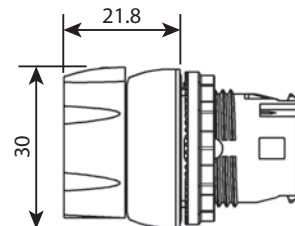

Dimensions in millimeters. Dimensions are not intended to be used for manufacturing purposes.

Illuminated and Non-Illuminated 2-Position Multi-Function Operators

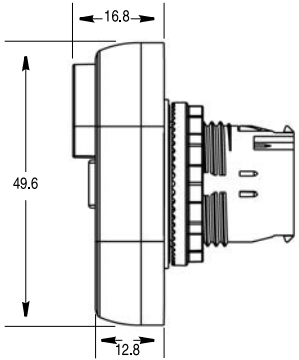

Non-Illuminated 3-Position Multi-Function Operators

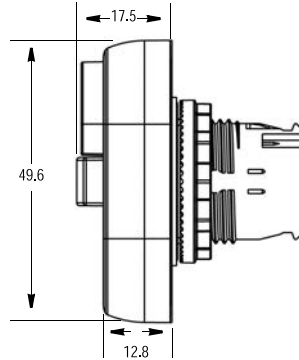

Potentiometer Operator

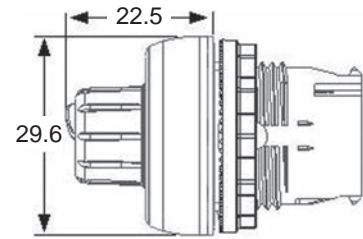

Illuminated and Non-Illuminated Knob Selector Switch Operators

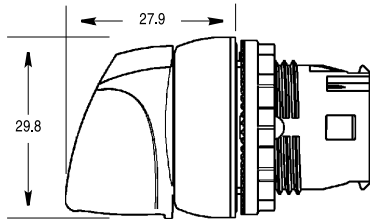

Non-Illuminated Knob Lever Selector Switch Operators

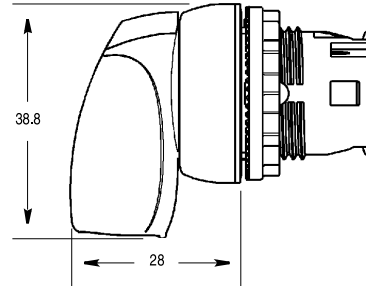

Illuminated and Non-Illuminated Twist-to-Release Operators 30 mm, 40 mm, and 60 mm

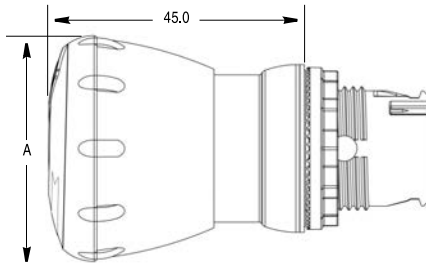

Illuminated and Non-Illuminated Push-Pull Mushroom Operators 30 mm, 40 mm, and 60 mm

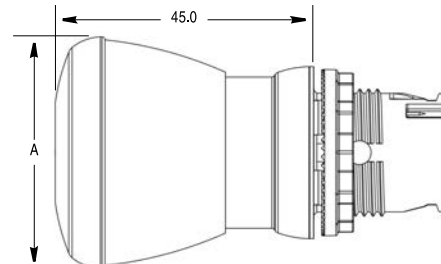

Operator	A
30 mm	30.0
40 mm	40.0
60 mm	60.0

Key Selector Switch and Key Ejected Senseject Operators

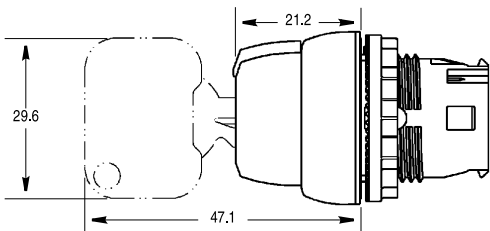

Mushroom Key Release Operator 40 mm

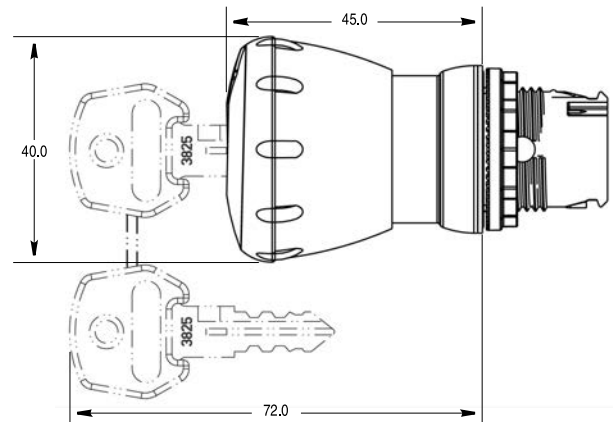

Dimensions in millimeters. Dimensions are not intended to be used for manufacturing purposes.

**Back-of-Panel Components —
Incandescent Module with Latch**

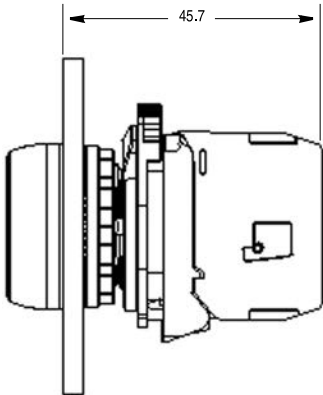

**Back-of-Panel Components —
LED Module with Latch**

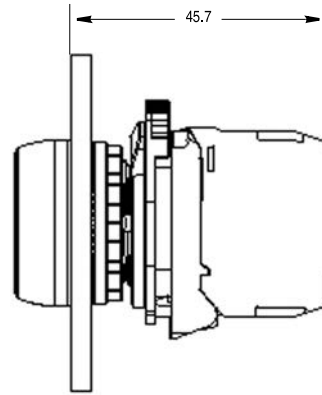

**Back-of-Panel Components —
Contact Cartridges with Latch**

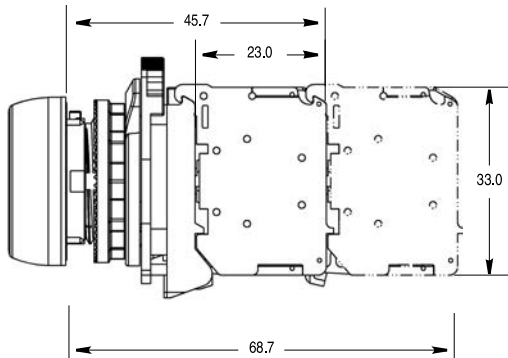

**Back-of-Panel Components —
Dual Circuit Contact Block or
Self Monitoring Contact Block
(Max. of 1 Deep)**

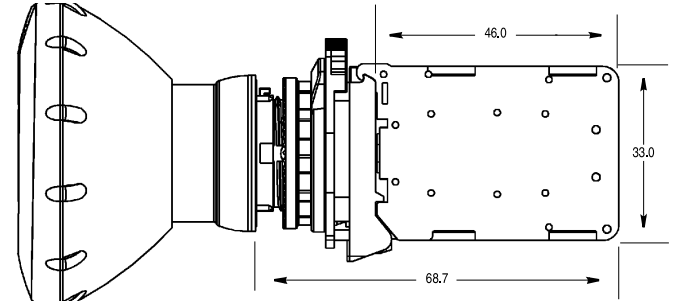

Potentiometer with Resistive Element

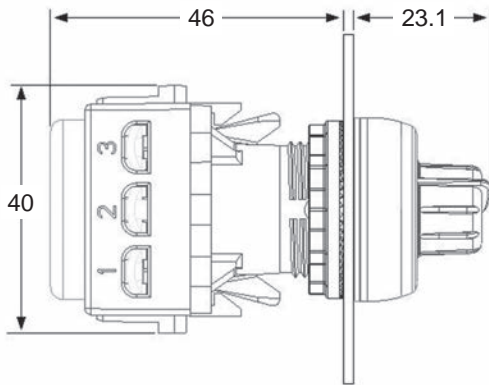

Customer Supplied Resistive Element

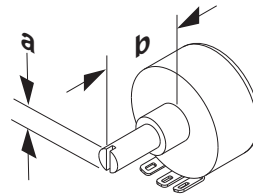

	Max.		Min.
a (Ø Dia.)	6.4 (0.252)	5.9 (0.232)	5.7 (0.224)
b (Length)	24 (0.945)	32 (1.26)	14 (0.551)

Dimensions in millimeters (inches).

30 x 40 mm Snap-In Legend Plate

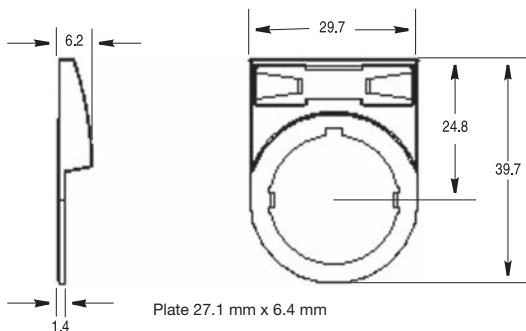

30 x 50 mm Snap-In Legend Plate

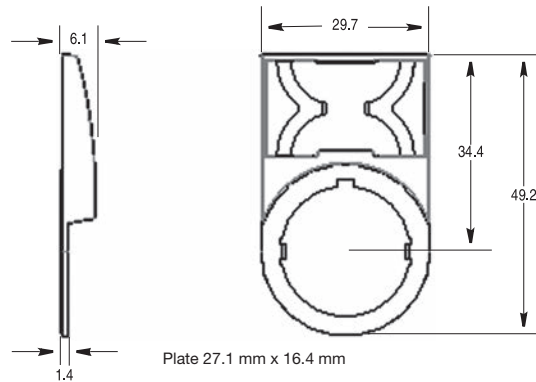

Dimensions in millimeters. Dimensions are not intended to be used for manufacturing purposes.

60 mm Round Legend — 15Y

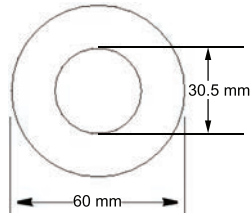

90 mm Round Legend

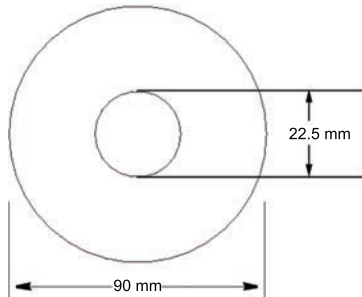

Trim Washer

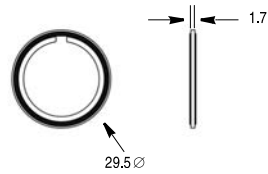

60 mm Round Legend — 15YS

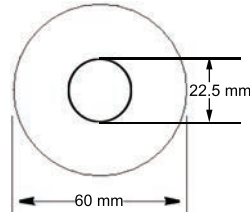

Potentiometer Legend Plate (Series A)

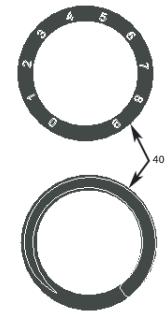

Anti-Rotation Washer

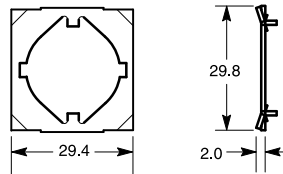

30 x 60 mm Snap-In Legend Plate

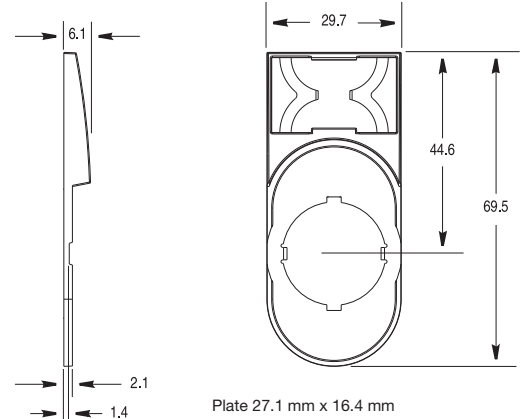

Special Multi-Function Snap-In Legend Plate

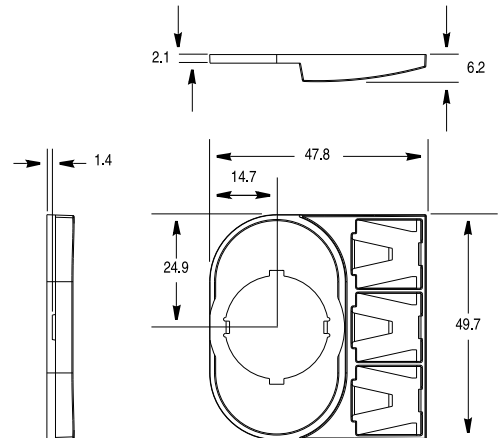

30 x 40 mm One-Piece Legend Plate

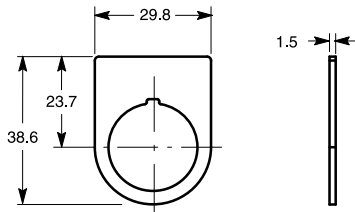

30 x 66 mm One-Piece Legend Plate

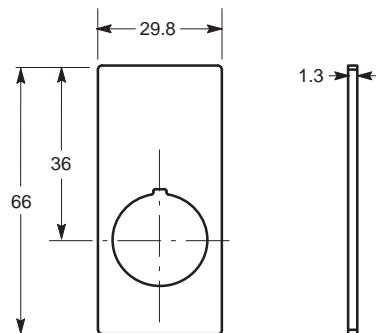

30 x 50 mm One-Piece Legend Plate

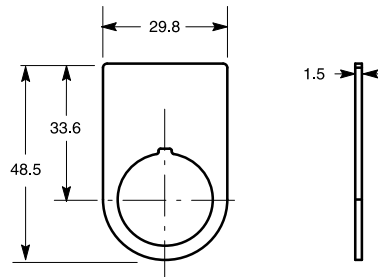

Hole Plug

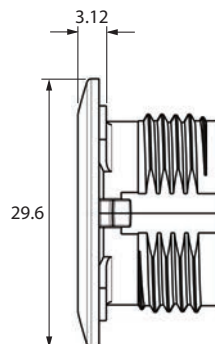

30 mm to 22.5 mm Hole Adapter

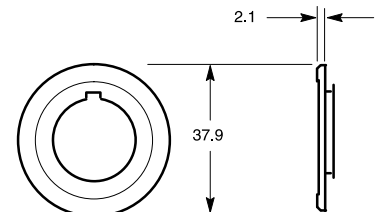

Base Mount Adapter

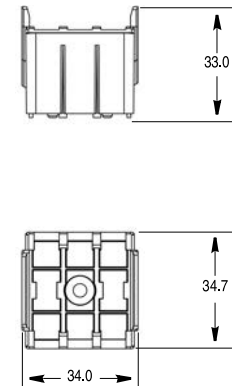

Note: Panel thickness range is 1.0...6.0 mm maximum.

Panel thickness reduced to 4 mm (standard anti-rotation washer) or 5 mm (thin anti-rotation washer) when optional legend plates are used.

Dimensions in millimeters. Dimensions are not intended to be used for manufacturing purposes.

Locking Cover

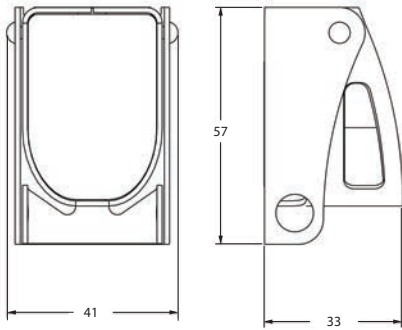

Maintained Mushroom Locking Attachment

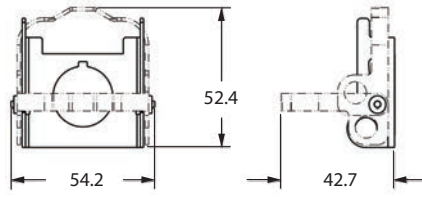

Momentary Mushroom Locking Attachment

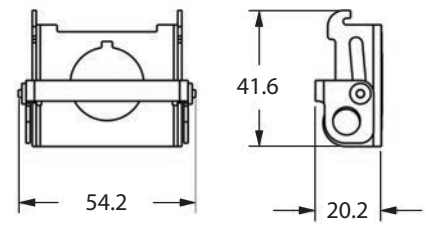

Extended Non-Illuminated Locking Attachment

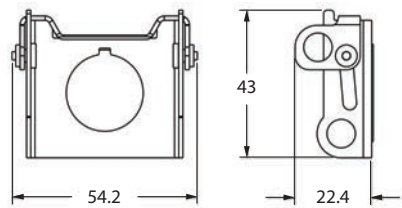

Flush Non-Illuminated Locking Attachment

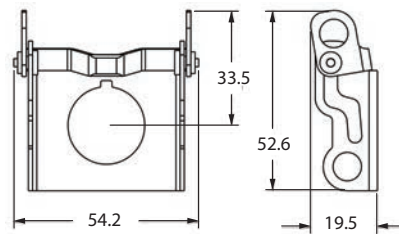

Selector Switch Locking Cover (Same for all Lock Positions)

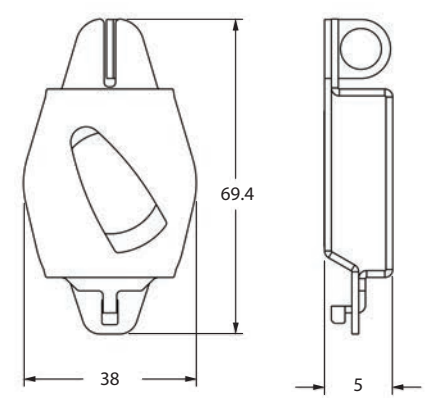

Narrow Guard

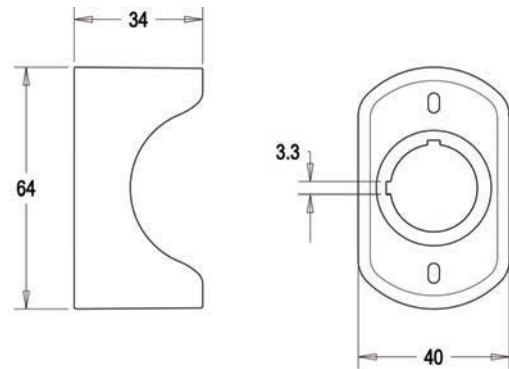

Protective Ring

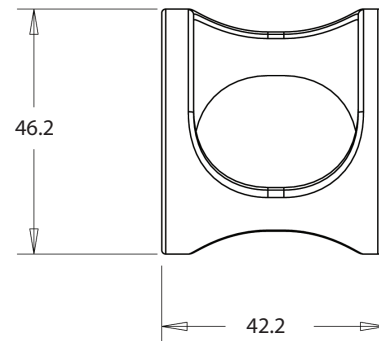

Plastic Guard

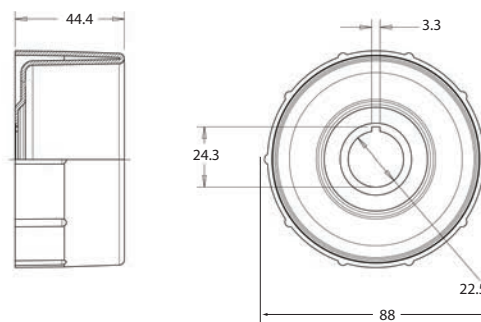

Assembled Station Pin Out Chart

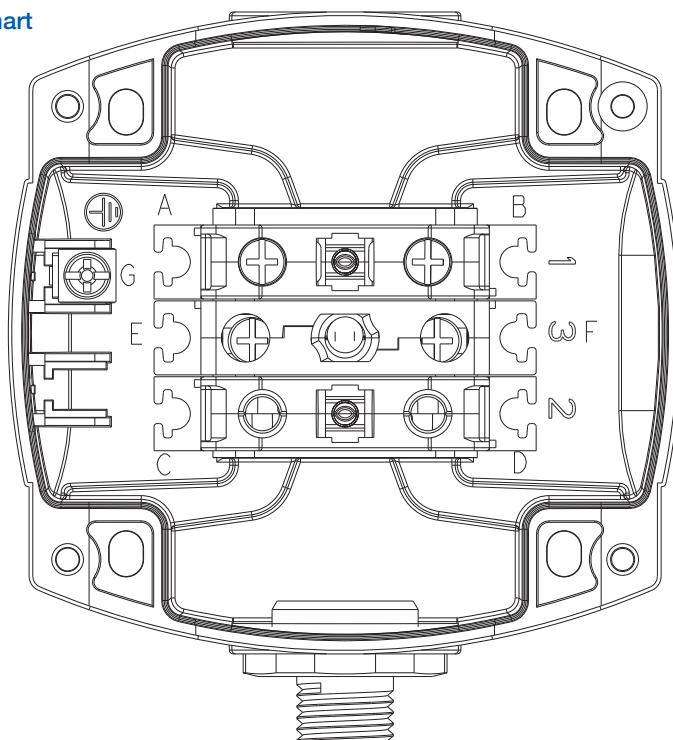

Cat. No.	Connector Style / No. of Pins	Location 1	A to Pin #	B to Pin #	Location 2	C to Pin #	D to Pin #	Location 3	E to Pin #	F to Pin #	G to Pin #
800F-1YMQ53V	AC Micro / 5-pin	BX01V	1	2	BX01V	4	5	—	—	—	3
800F-1YMQA	AC Micro / 6-pin	BX01	1	5	BX01	2	6	BX10	3	4	—
800F-NX1	DC Micro / 4-pin	BX01	1/4	2/3	—	—	—	—	—	—	—
800F-1YMQ1		BX01	1/4	2/3	—	—	—	—	—	—	—
800F-1YMQ2		BX10V	2	4	BX01V	1	3	—	—	—	—
800F-1YMQ3		BX01V	1	3	BX01V	2	4	—	—	—	—
800F-1YMQ3VEG		BX01V	1	3	BX01V	2	4	—	—	—	—
800F-1YMQ3V		DC Micro / 5-pin	BX01V	1	2	BX01V	4	5	—	—	—
800F-1YMQ41	Mini Receptacle / 4-pin	BX01	2	4	—	—	—	—	—	—	—
800F-1YMQ44		BX10	1	J	BX01	2	4	BN3R	3	J	J
800F-1YMQ4	Mini Receptacle / 6-pin	BX10	1	J	BX01	6	5	BN3R	2	J	J
800F-1YMQ5		BX10	1	J	BX01	6	5	BN5R	2	J	J
800F-1YMQ6		BX10	1	J	BX01	6	5	BN7R	2	J	J
800F-1MYMQ4		BX10	1	J	BX01	6	5	BN3R	2	J	J
800F-1MYMQ5		BX10	1	J	BX01	6	5	BN5R	2	J	J
800F-1MYMQ6		BX10	1	J	BX01	6	5	BN7R	2	J	J

J = Jumper

General Purpose Push Button Enclosures

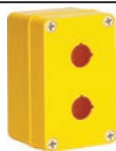

Bulletin	598
Description	Push Button Enclosure
Features	Designed to house 22.5 mm push buttons (available in grey or yellow colors)
Dimensions [mm]	Available in 4 sizes (Height x Width x Depth) 1-Hole: 110 x 80 x 85 2-Hole: 130 x 80 x 85 3-Hole: 180 x 80 x 85 4-Hole: 250 x 80 x 85
Degree of Protection	Type 1, 4, 4X, 12, 13 IP66 Indoor/Outdoor
Storage Temperature Range	-40...+75 °C (-40...+158 °F)
Operating Temperature Range	-40...+55 °C (-40...+131 °F)
Material	
Enclosure	Thermoplastic polyester blend, UL94-5VA
Gasket	Foam-in-place polyurethane
Standards	UL 508A and CSA C22.2, No. 14
Certifications	cULus, CE

Technical Specifications

Product Certification	
Approvals/Certifications	cULus Listed (File No. E54866; Guide No. NITW, NITW7), CE Marked
Degree of Protection	Type 4, 4X, 12, and 13, IP66
Environmental	
Storage Temperature Range	-40...+75 °C (-40...+158 °F)
Operating Temperature Range	-40...+55 °C (-40...+131 °F)
Material	
Enclosure	Thermoplastic polyester blend, UL94 5VA
Gasket	Foam-in-place polyurethane

Operator Mounting - Vertical vs. Horizontal Definition

Due to the design of the enclosures, operators are mounted in both a vertical and horizontal orientation. The easiest way to visualize the operator orientation is by observing the contact block direction attached to the operators. If the contact blocks are mounted vertically the operator is mounted vertically in the enclosure. Vertical mounted operators are only found in position 2 & 3 of the 3-hole enclosure. If the contact blocks are mounted horizontally the operator is mounted horizontally in the enclosure. Horizontal mounted operators are found in position 1 of the 3-hole enclosure and all positions of the 5-...9-hole enclosures. It is necessary to know this when ordering individual operators for populating at the customer location.

Operator Sequence when using a Mechanical Interlock

The 1-, 2-, and 3-speed operators can be mounted with either our standard **Cat. No. 800F-ALP** latch or a mechanical interlocking latch (**Cat. No. 800FC-ALP**). For the 3-hole enclosure, the mechanical interlock can only be located in positions 2 & 3, with the black operator being located in position 2 and the white operator being located in position 3. For the 5-...9-hole enclosures, the mechanical interlock can be located in any two adjacent positions. For the 5-...9-hole enclosures, the white operator will be located in position X of the mechanical interlock and the black operator will be located in position X+1 of the mechanical interlock.

Operator Assembly Sequence and Mounting Orientation

Vertical Mount Operators

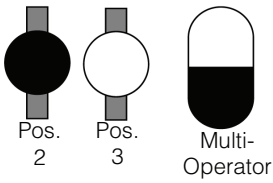

Horizontal Mount Operators

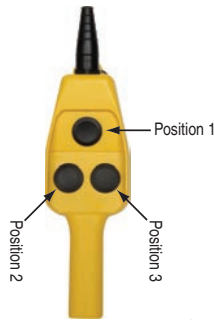

3-Hole Enclosure★

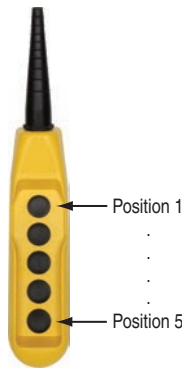

5-Hole Enclosure‡

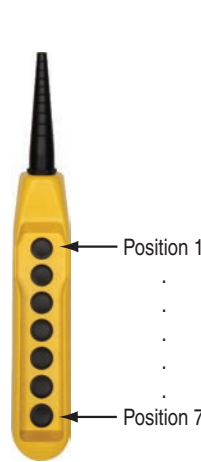

7-Hole Enclosure‡

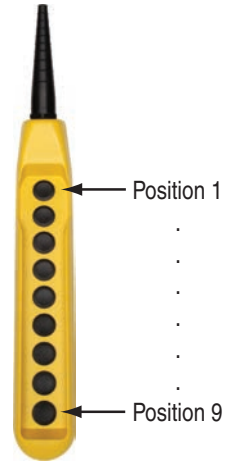

9-Hole Enclosure‡

★ Operator in Position 1 is mounted horizontal, contact blocks are horizontal. Operators in Positions 2 & 3 are mounted vertical, contact blocks are vertical.
 ‡ Operators in all positions are mounted horizontal, contact blocks are horizontal.

1-, 2-, and 3-Speed Operators ♣△

800FP – C A 1 U243
a b c



a

Operator Type	
Code	Description
A	1-speed single arrow
D	1-speed double arrow
B	2-speed
C	3-speed‡

‡ Proper contact block assembly of these devices is required.

b

Cap Color	
Code	Description
1	White
2	Black

Arrow Direction Chart

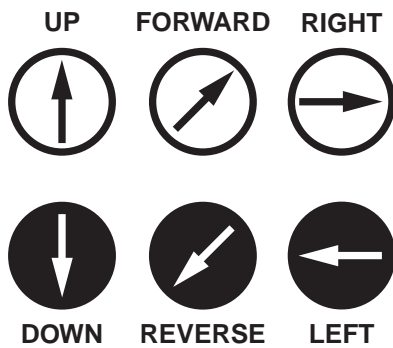

c

		Symbol					
		Code	Valid with Table a Selections:	Description§			
				Vertical Mounting		Horizontal Mounting	
		Black with White Arrow	White with Black Arrow	White with Black Arrow	Black with White Arrow		
	U100	A, B, C	Blank	Blank	Blank	Blank	
	One-Speed Operators						
	U241	A	DOWN	UP	—	—	
	U243		—	—	RIGHT	LEFT	
	U244		REVERSE	FORWARD	—	—	
	U246		—	—	FORWARD	REVERSE	
	U700		LEFT	RIGHT	UP	DOWN	
	U261	D	DOWN FAST	UP FAST	—	—	
	U263		—	—	RIGHT FAST	LEFT FAST	
	U264		REVERSE FAST	FORWARD FAST	—	—	
	U266		—	—	FORWARD FAST	REVERSE FAST	
	U260		LEFT FAST	RIGHT FAST	UP FAST	DOWN FAST	
	Two-Speed Operators						
	U271	B	2-speed DOWN	2-speed UP	—	—	
	U273		—	—	2-speed RIGHT	2-speed LEFT	
	U274		2-speed REVERSE	2-speed FORWARD	—	—	
	U276		—	—	2-speed FORWARD	2-speed REVERSE	
	U270		2-speed LEFT	2-speed RIGHT	2-speed UP	2-speed DOWN	
	Three-Speed Operators						
	U291	C	3-speed DOWN	3-speed UP	—	—	
	U293		—	—	3-speed RIGHT	3-speed LEFT	
	U294		3-speed REVERSE	3-speed FORWARD	—	—	
	U296		—	—	3-speed FORWARD	3-speed REVERSE	
	U290		3-speed LEFT	3-speed RIGHT	3-speed UP	3-speed DOWN	

Note: Please consult your local Rockwell Automation sales office or Allen-Bradley distributor for proper latch and contact block configurations.

§ Text (DOWN, UP, LEFT, etc.) indicates arrow direction. Text is **not** printed on operators.

♣ Cat. No. 800F-ALP (standard latch) and Cat. No. 800FC-ALP (mechanical interlock latch) can be used with these operators.

△ Booted style of operators for pendant stations.

Catalog Number Explanation
Configured Pendant Stations

800FC –

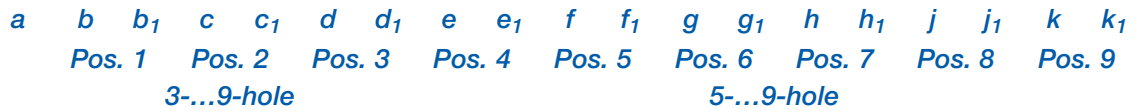

Note: A code from Tables *b...k* and *b₁...k₁* must be specified for each operator to create a valid cat. no.

a

Enclosure Code					
Voltage ¹²	Legend Plate	3-Hole	5-Hole	7-Hole	9-Hole
		Code	Code	Code	Code
24V AC/DC	No	2	4	6	8
120V AC		3	5	7	9
24V AC/DC	Yes	A	C	E	G
120V AC		B	D	F	H

- ¹² Enclosure code is always required. Voltage is used to select LEDs for illuminated operators. Standard contact blocks are used for both 24V and 120V enclosures.
- * Only available in position 1 of a 3-hole enclosure and in positions 1 & 2 of a 5-...9-hole enclosure.
- ‡ Monolithic style device provided.
- § For a 3-hole enclosure, when a mechanical interlock (*c1* & *d1* = M or B) is selected with a 1-...3-speed operator, the black operator will be located in position 2 of the enclosure and the opposite white operator will be placed in position 3 of the enclosure (Example: ABMAFM or BDMBUM). For a 5-...9-hole enclosure, when a mechanical interlock (*b1...k1* = M or B) is selected with a 1-...3-speed operator, the white operator will be located in position X of the mechanical interlock and the opposite black operator will be placed in position X+1 of the mechanical interlock (Example: AFMABM or BUMBDM).
- ♣ Interlock and/or rubber boot selection = N (no interlock, no additional boots) is **not** allowed.
- △ Interlock and/or rubber boot selection = E (electrical interlock, no additional boots) is **not** allowed.
- ◆ Interlock and/or rubber boot selection = M (mechanical interlock) is **not** allowed.
- ♠ Interlock and/or rubber boot selection = B (electrical and mechanical interlock) is **not** allowed.
- ∇ Interlock and/or rubber boot selection = R (no interlock, additional rubber boot) is **not** allowed.
- ⊗ Interlock and/or rubber boot selection = S (electrical interlock, additional rubber boot) is **not** allowed.
- # Only available in position 1 for a 3-hole enclosure, positions 1 and/or 5 for a 5-hole enclosure, positions 1 and/or 7 for a 7-hole enclosure, and positions 1 and/or 9 for a 9-hole enclosure.
- ¹¹ For proper installation, a trim washer or Cat. No. 800F-36_ legend plate must be installed with this operator.

b₁...k₁

Interlock and/or Rubber Boot	
Code	Description
N	No interlock, no additional boots
E	Electrical interlock, no additional boots
M	Mechanical interlock, boots standard §
B	Electrical and mechanical interlock, boots standard §
R	No interlock, additional rubber boot
S	Electrical interlock, additional rubber boot

b...k

Operator Type		
Single Speed Operators for use with Mechanical Interlock §∇& ¹¹		
Code	Description	Legend Plate Text (When Selected)
A2	Black operator (no text or symbol)	Blank
AB	Black operator with arrow (reverse — down/left)	O/H CRANE, REVERSE
AD	Black operator with arrow (down)	LIFT, DOWN
AL	Black operator with arrow (left)	HOIST, LEFT
A1	White operator (no text or symbol)	Blank
AF	White operator with arrow (forward — up/right)	O/H CRANE, FORWARD
AR	White operator with arrow (right)	HOIST, RIGHT
AU	White operator with arrow (up)	LIFT, UP
Fast Single Speed Operators for use with Mechanical Interlock §∇& ¹¹		
Code	Description	Legend Plate Text (When Selected)
DB	Black operator with double arrow (reverse fast — down/left)	O/H CRANE, REVERSE, FAST
DD	Black operator with double arrow (down fast)	LIFT, DOWN FAST
DL	Black operator with double arrow (left fast)	O/H CRANE, LEFT FAST
DF	White operator with double arrow (forward fast — up/right)	O/H CRANE, FORWARD, FAST
DR	White operator with double arrow (right fast)	O/H CRANE, RIGHT FAST
DU	White operator with double arrow (up fast)	LIFT, UP FAST
Two-Speed Operators for use with Mechanical Interlock §∇& ¹¹		
Code	Description	Legend Plate Text (When Selected)
B2	Black operator (no text or symbol)	Blank
BB	Black operator with arrow (reverse — down/left)	1-2 SPEED, O/H CRANE, REVERSE
BD	Black operator with arrow (down)	1-2 SPEED, LIFT, DOWN
BL	Black operator with arrow (left)	1-2 SPEED, HOIST, LEFT
B1	White operator (no text or symbol)	Blank
BF	White operator with arrow (forward — up/right)	1-2 SPEED, O/H CRANE, FORWARD
BR	White operator with arrow (right)	1-2 SPEED, HOIST, RIGHT
BU	White operator with arrow (up)	1-2 SPEED, LIFT, UP
Three-Speed Operators for use with Mechanical Interlock §*Δ∇& ¹¹		
Code	Description	Legend Plate Text (When Selected)
C2	Black operator (no text or symbol)	Blank
CB	Black operator with arrow (reverse — down/left)	1-2-3 SPEED, O/H CRANE, REVERSE
CD	Black operator with arrow (down)	1-2-3 SPEED, LIFT, DOWN
CL	Black operator with arrow (left)	1-2-3 SPEED, HOIST, LEFT
C1	White operator (no text or symbol)	Blank
CF	White operator with arrow (forward — up/right)	1-2-3 SPEED, O/H CRANE, FORWARD
CR	White operator with arrow (right)	1-2-3 SPEED, HOIST, RIGHT
CU	White operator with arrow (up)	1-2-3 SPEED, LIFT, UP

b...k, continued

Operator Type		
Emergency Stop Operators $\star\Delta\blacklozenge\blacktriangle\blacktriangledown\&$		
Code	Description	Legend Plate Text (When Selected)
MT	Red operator — twist-to-release	Not provided
ME	Illuminated red operator — twist-to-release	
MK	Red operator — keyed twist-to-release	
MM	Red operator — twist-to-release/push-pull \ddagger	
MG	Red operator with guard — twist-to-release/push-pull \ddagger	
Standard Extended Push Buttons — Non-Illuminated $\blacklozenge\blacktriangle$		
Code	Description	Legend Plate Text (When Selected)
E2	Black operator (no text or symbol)	Blank
ED	Black operator with arrow (down)	LIFT, DOWN
EL	Black operator with arrow (left)	HOIST, LEFT
EB	Black operator with arrow (reverse — down/left)	O/H CRANE, REVERSE
FD	Black operator with double arrow (down fast)	LIFT, DOWN FAST
FL	Black operator with double arrow (left fast)	O/H CRANE, LEFT FAST
FB	Black operator with double arrow (reverse fast — down/left)	O/H CRANE, REVERSE, FAST
E1	White operator (no text or symbol)	Blank
EU	White operator with arrow (up)	LIFT, UP
ER	White operator with arrow (right)	HOIST, RIGHT
EF	White operator with arrow (forward — up/right)	O/H CRANE, FORWARD
FU	White operator with double arrow (up fast)	LIFT, UP FAST
FR	White operator with double arrow (right fast)	O/H CRANE, RIGHT FAST
FF	White operator with double arrow (forward fast — up/right)	O/H CRANE, FORWARD, FAST
E3	Green operator (no text or symbol) $\Delta\&$	Blank
EQ	Green operator with Start/Alarm symbol $\Delta\&$	START, ALARM
EN	Green operator with Start symbol $\Delta\&$	START
E4	Red operator (no text or symbol) $\Delta\&$	Blank
ES	Red operator with Stop symbol $\Delta\&$	STOP
E5	Yellow operator (no text or symbol) $\Delta\&$	Blank
EA	Yellow operator with Alarm symbol $\Delta\&$	ALARM
E6	Blue operator (no text or symbol) $\Delta\&$	Blank
R6	Blue operator with R $\Delta\&$	RESET
Standard Extended Push Buttons — Illuminated $\Delta\blacklozenge\blacktriangle\&$		
Code	Description	Legend Plate Text (When Selected)
L3	Green operator (no text or symbol)	Blank
L4	Red operator (no text or symbol)	Blank
L5	Yellow operator (no text or symbol)	Blank
L6	Blue operator (no text or symbol)	Blank
L7	Clear operator (no text or symbol)	Blank
Selector Switches $\Delta\blacklozenge\blacktriangle\&$		
Code	Description	Legend Plate Text (When Selected)
SH	2-position	Standard-maintained
KH		Keyed-maintained
SJ	3-position	Standard-maintained
KJ		Keyed-maintained

Note: Footnote explanations on previous page.

b...k, continued

Operator Type		
2- Function Multi-Operator Push Buttons $\Delta\blacklozenge\blacktriangle\&$		
Code	Description	Legend Plate Text (When Selected)
VV	Black/white operator with arrow (down & up)	Not provided
VW	Black/white operator with arrow (left & right)	
VX	Black/white operator with arrow (reverse & forward)	
WV	Black/white operator, illuminated, with arrow (down & up)	
WW	Black/white operator, illuminated, with arrow (left & right)	
WX	Black/white operator, illuminated, with arrow (reverse & forward)	
XV	Black/white operator with double arrows (down fast & up fast)	
XW	Black/white operator with double arrows (left fast & right fast)	
XX	Black/white operator with double arrows (reverse fast & forward fast)	
YV	Black/white operator, illuminated, with double arrows (down fast & up fast)	
YW	Black/white operator, illuminated, with double arrows (left fast & right fast)	
YX	Black/white operator, illuminated, with double arrows (reverse fast & forward fast)	
Pilot Lights $\ddagger\Delta\blacklozenge\blacktriangle\&$		
Code	Description	Legend Plate Text (When Selected)
P0	Amber LED	Blank
P3	Green LED	Blank
P4	Red LED	Blank
P5	Yellow LED	Blank
P6	Blue LED	Blank
P7	Clear LED	Blank
Potentiometers $\Delta\blacklozenge\blacktriangle\&\#$		
Code	Description	Legend Plate Text (When Selected)
1P	Black operator — 150 Ω	Blank
2P	Black operator — 500 Ω	Blank
3P	Black operator — 1000 Ω	Blank
4P	Black operator — 2500 Ω	Blank
5P	Black operator — 5000 Ω	Blank
6P	Black operator — 10 000 Ω	Blank
Hole Plug $\Delta\blacklozenge\blacktriangle\&$		
Code	Description	Legend Plate Text (When Selected)
N2	Black hole plug	Blank

b₁...k₁

Interlock and/or Rubber Boot	
Code	Description
N	No interlock, no additional boots
E	Electrical interlock, no additional boots
M	Mechanical interlock, boots standard \S
B	Electrical and mechanical interlock, boots standard \S
R	No interlock, additional rubber boot
S	Electrical interlock, additional rubber boot

Specifications★

Front-of-Panel (Operators)

Mechanical Ratings	
Description	Plastic (Bulletin 800FP)
Vibration (assembled to panel)	Tested at 10...2000 Hz, 1.52 mm displacement (peak-to-peak) max./10 G max. for 3 hr duration, no damage
Shock	Tested at 1/2 cycle sine wave for 11 ms; no damage at 100 G
Degree of protection‡	IP66 (Type 4/4X/13)
	Momentary push buttons
Mechanical durability per EN 60947-5-1 (Annex C)	Multi-function, selector switch, key selector switch
10 000 000 Cycles	Twist-to-release E-stop, illuminated push-pull E-stop, alternate action push buttons
1 000 000 Cycles	Potentiometer, toggle switch
300 000 Cycles	
100 000 Cycles	
Operating forces (typical with one contact block)	Flush/extended = 5 N, E-stop = 36 N
Operating torque (typical application with one contact block)	Selector switch = 0.25 N•m (2.2 lb•in)
Mounting torque	1.7 N•m (15 lb•in)
Environmental	
Temperature range (operating)	-25...+70 °C (-13...+158 °F)§
Temperature range (short term storage)	-40...+85 °C (-40...+185 °F)
Humidity	50...95% RH from 25...60 °C (77...140 °F)

★ Performance Data — see note on page 3.

‡ Plastic keyed operators are IP66, Type 4/13; not Type 4X.

§ Operating temperatures below 0 °C (32 °F) are based on the absence of freezing moisture and liquids, UL Recognized to 55 °C (131 °F) - Incandescent module max. 40 °C (104 °F) - fully populated 9-hole pendant enclosure 45 °C (113 °F) with 75 °C wire.

Note: Use UL Listed type S or SJ cords, with a smooth outer jacket rated for wet locations use (marked W) and oil resistant outer covering (marked O) such as SOW or SJOW with copper wire, rated 75 °C min., 18...12 AWG, with an overall OD of 7.5...15 mm for the small cable sleeve (**Cat. No. 800FC-AS3**) and 9...22.5 mm for the large cable sleeve (**Cat. No. 800FC-AS5**).

Product Certifications

Certifications	UR/UL, CSA, CCC, CE
Standards Compliance	NEMA ICS-5, UL 508, CSA C22.2 No. 14, EN ISO 13850, EN 60947-1, EN 60947-5-1, EN 60947-5-5
Terminal Identification	EN/IEC 60947-1
RoHS	✓

Material Listing

Component	For Use with	Material Used
Panel gasket	All operators	Nitrile, TPE
Diaphragm seal	Illuminated push button, non-illuminated push button	Automotive industry acceptable silicone
K-seal	Selector switch, key selector switch, push/twist-to-release E-stop, key E-stop	Nitrile
Diaphragm retainer, return spring I	Illuminated push button, non-illuminated push button	Stainless steel
Return spring II	Selector switch, key selector switch, alternate action, push/twist-to-release E-stop, key E-stop	Zinc-coated music wire
Button cap	Non-illuminated push button, push/twist-to-release, E-stop, key E-stop, multi-function	PBT/polycarbonate blend
2-color molded button cap	Non-illuminated push button	PBT/polycarbonate blend
Lens	Multi-function	Acetal
Lens, knob	Illuminated push button	Polyamide
Knob	Non-illuminated selector switch	Glass-filled polyamide
Plastic bezel/bushing I	Non-illuminated push button, illuminated push button, selector switch, key selector switch, push/twist-to-release E-stop, key E-stop, multi-function	Glass-filled polyamide
Plastic bezel/bushing II	Pilot light	Glass-filled PBT
Diffuser	Illuminated push button, pilot light	Polycarbonate
Plastic mounting ring	All plastic operators	Glass-filled polyamide
Plastic latch	—	Glass-filled polyamide
Mechanical interlock latch	—	Glass-filled polyamide
Plastic enclosure	—	PBT/polycarbonate blend
Terminal screws	LED module, contact blocks	Zinc-plated steel with chromate
Terminals	LED module, contact blocks	Brass with silver-nickel contacts
Housing	LED module	Glass-filled polyamide
Low-voltage terminals	Contact blocks	Gold-plated silver-nickel contacts
Low-voltage spanner	Contact blocks	Gold-plated silver-nickel contacts
Spanner	Contact blocks	Brass with silver-nickel contacts
Boot	Illuminated push button, non-illuminated push button, multi-function illuminated and non-illuminated	Automotive industry acceptable silicone

Back-of-Panel Components

Electrical Ratings			
Standard contact block ratings		A600, Q600 600V AC AC 15, DC 13 to IEC/EN 60947-5-1 and UL 508, 17V, 5 mA min.	
Low voltage contact block ratings*		5V, 1 mA DC min. C300, R150, AC 15, DC 13 to EN 60947-5-1 and UL 508	
Nominal Voltage		Range	Current Draw
LED Module Ratings	24V AC	10...29V AC	31 mA
	24V DC	10...30V DC	24 mA
	120V AC	70...132V AC	25 mA
	240V AC	180...264V AC	22 mA
Frequency		50/60 Hz	
Thermal current		10 A max. enclosed (40 °C ambient) to UL508, EN 60947-5-1	
Insulation voltage (U _i)		Screw terminal = 690V, spring-clamp = 300V	
Wire capacity (screw terminal)‡		#18...12 AWG (0.75...2.5 mm ²) Max. (2) #14 AWG or (1) #12 AWG	
Wire capacity (spring-clamp terminal)		#18...14 AWG (0.75...1.5 mm ²) One per spring clamp, two spring clamps per terminal	
Recommended tightening torque on screw terminals		0.7...0.9 N•m (6...8 lb•in)	
Dielectric strength (minimum)		2500V for one minute	
External short circuit protection	Standard blocks	10 A type gL/gG cartridge fuse to EN 60269-2-1 or gN (Class J to UL 248-8 or Class C to UL 248-4)	
	Low voltage contact blocks	6 A type gL/gG cartridge fuse to EN 60269-2-1 or gN (Class J to UL 248-8 or Class C to UL 248-4)	
Electrical shock protection		Finger-safe conforming to IP2X	
Mechanical Ratings			
Vibration (assembled to panel)		Tested at 10...2000 Hz, 1.52 mm displacement (peak-to-peak) max./10 G max. 6 hr	
Shock		Tested at 1/2 cycle sine wave for 11 ms and no damage at 100 G max.	
Contact durability per EN 60947-5-1 (Annex C)		10 000 000 cycles	
Contact operation	N.O.	Slow double make and break	
	N.C.	Slow double make and break — positive opening ⊖	
	N.O.E.M.	Double break / double make, early make	
	N.C.L.B.	Double break / double make, late break — positive opening ⊖	
	N.C.E.B.	Double break / double make, early break — positive opening ⊖	
	N.O.E.E.M.	Double break / double make, early early make	
	N.O.L.M.	Double break / double make, late make	
Standard push button travel to change electrical state	N.C. and N.O.E.M.	1.5 mm (0.060 in.)	
	N.O. and N.C.L.B.	2.5 mm (0.1 in.)	
Multi-speed push button travel to change electrical state	N.O.E.E.M.	3 mm (0.12 in.)	
	N.C.E.B.	4 mm (0.16 in.)	
	N.O.L.M.	7 mm (0.28 in.)	
Operating forces (typical)	Single-circuit contact block	3.4 N	
	Dual-circuit contact block	5...6.5 N	
Illumination			
LED Dominant Wavelength	Green	525 nm	
	Red	629 nm	
	Yellow	590 nm	
	Blue	470 nm	
	White	—	
LED Luminous Intensity	Green	780 mcd	
	Red	780 mcd	
	Yellow	600 mcd	
	Blue	168 mcd	
	White	360 mcd	
Materials			
Springs		Stainless steel and zinc coated music wire	
Electrical contacts	Standard	Silver-nickel	
	Low voltage	Gold-plated over silver	
Terminals	Screw	Brass	
	Spring-clamp	Silver-plated brass	

* Performance Data — see note on page 3.

* Low voltage contacts are recommended for applications below 17V, 5 mA.

‡ Wires less than #18 AWG (0.75 mm²) may not hold in terminal securely.

Approximate Dimensions ★

Bul. 800FC 1-, 2-, and 3-Speed Operator

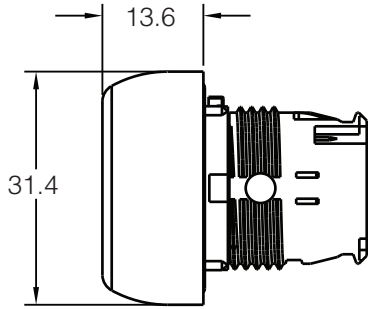

Bul. 800FC Legend Plate

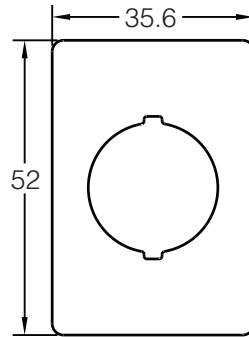

Bul. 800FC Pendant Station (3-Hole)

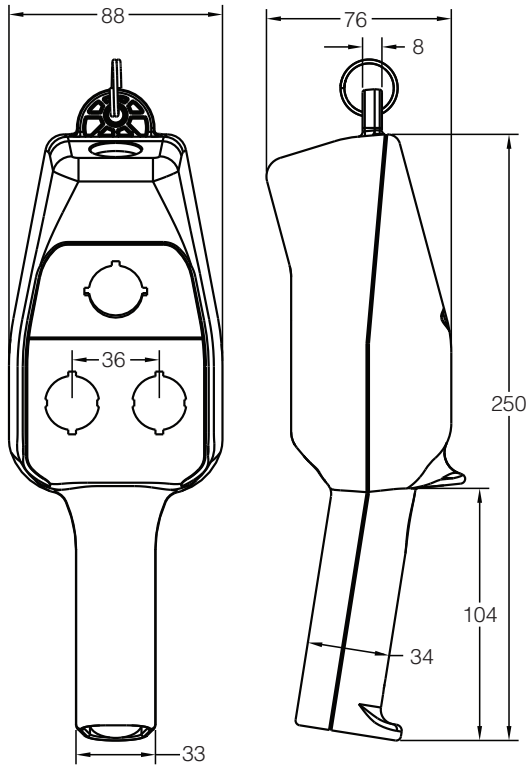

Bul. 800FC Pendant Station (5-, 7-, and 9-Hole)

Cat. No.	No. of Holes	A	B
800FC-4/5/C/D	5	309	36
800FC-6/7/E/F	7	381	36
800FC-8/9/G/H	9	453	36

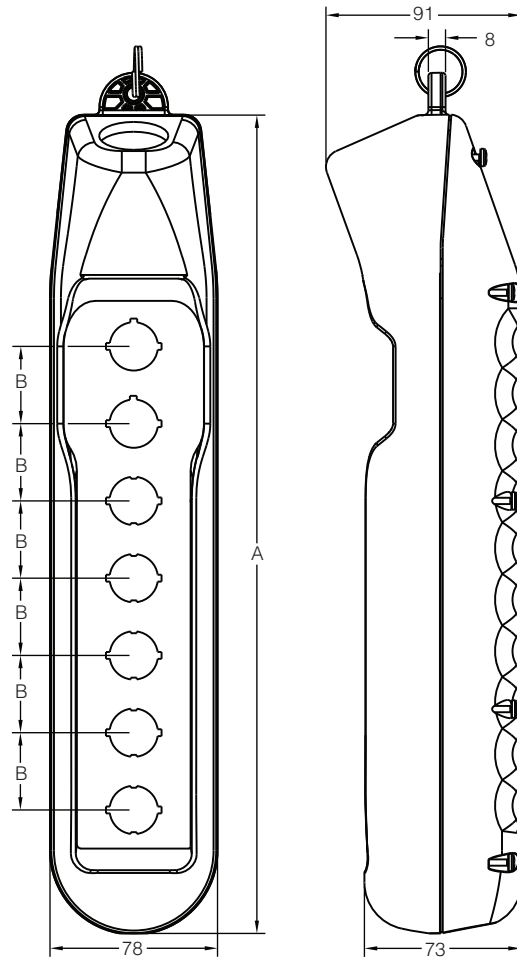

★ For Bul. 800F operator dimensions, see page 33.

Custom Text Fax/Scan Sheet

Order/Item _____

Vertical Mounting

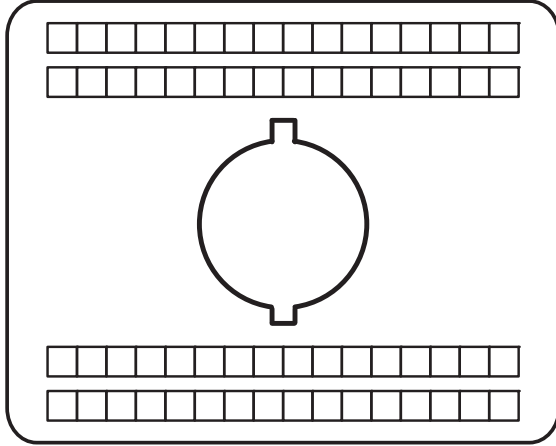

Cat. No. 800F-36VE100K

Horizontal Mounting

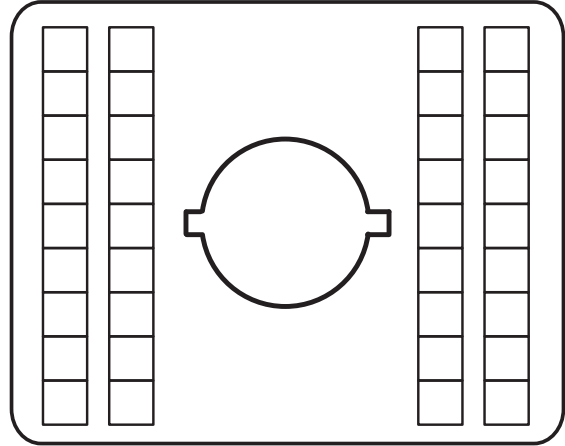

Cat. No. 800F-36HE100K

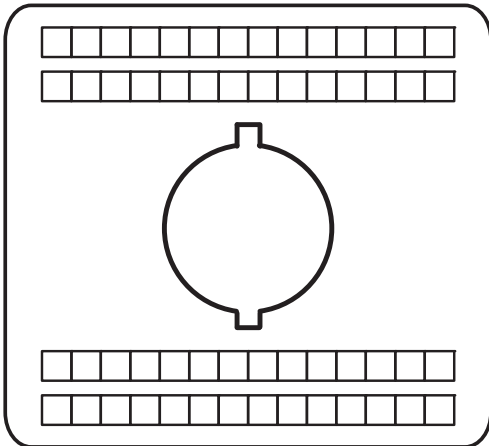

Cat. No. 800F-36VE100S

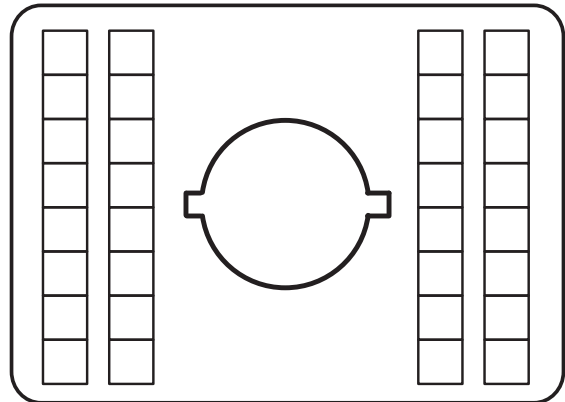

Cat. No. 800F-36HE100S

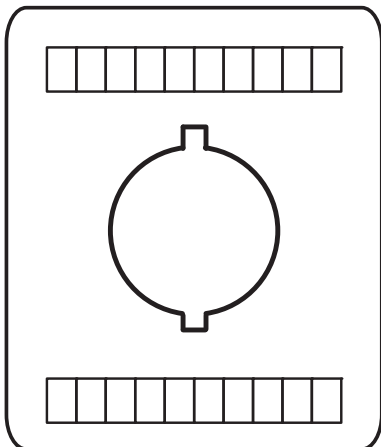

Cat. No. 800F-36VE100L

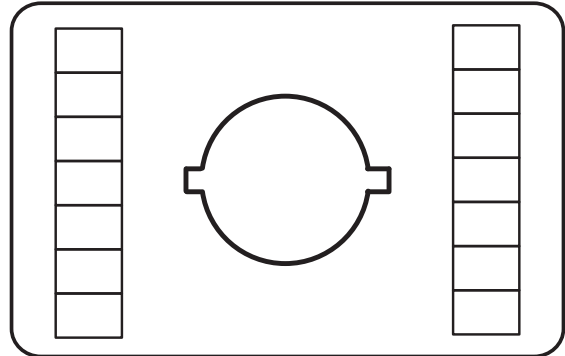

Cat. No. 800F-36HE100L

Momentary Push Button Operators, Non-Illuminated



800FD – F 3 01 X 11
a *b* *c* *d* *e*

a

Operator Type	
Code	Description
F	Flush
E	Extended

b

Color Cap	
Code	Color
1	White
2	Black
3	Green
4	Red
5	Yellow
6	Blue

c

Legend Text *‡	
Code	Text
—	No text (blank)
01	START
02	STOP
05	O
06	I
08	→
09	FORWARD
10	REVERSE
11	R

* White and yellow caps have black text. All other color caps have white text.

‡ Valid color cap/legend text combinations are as follows:

Color	Text	
	Flush Caps	Extended Caps
White	START, I, →, FORWARD, REVERSE, R	→, R
Black	→, FORWARD, REVERSE, R	STOP, O, →, R §
Green	START, I, →, FORWARD, REVERSE	→
Red	→, FORWARD, REVERSE	STOP, O, → §
Yellow	→, FORWARD, REVERSE	→
Blue	→, FORWARD, REVERSE, R	→, R

§ "STOP" or "O" color cap/legend text are not available for "10" or "20" contact modules.

d

Termination Style	
Code	Description
X	Standard screw
R	Ring lug

e

Contact Module		
Code	Number of N.O.	Number of N.C.
01	0	1
10	1	0
11	1	1
02	0	2
20	2	0

Pilot Light Devices — LED



800FD - P 3 N 7
a *b* *c*

a

Lens Cap	
Code	Color
0	Amber
3	Green
4	Red
5	Yellow
6	Blue
7	Clear

b

Voltage	
Code	Type
3	24V AC/DC
5	120V AC
7	240V AC

c

Termination Style	
Code	Description
Blank	Standard screw
R	Ring lug

Pilot Light Devices — Incandescent

800FD - P 3 D 5
a *b* *c*

a

Lens Cap	
Code	Color
0	Amber
3	Green
4	Red
5	Yellow
6	Blue
7	Clear
9	No lens★

b

Voltage	
Code	Type
0	No Bulb‡
1	6V AC/DC
2	12V AC/DC
3	24V AC/DC
4	48V AC/DC
5	120V AC/DC

c

Termination Style	
Code	Description
Blank	Standard screw
R	Ring lug

★ Only valid with "no bulb" option.

‡ Only valid with "no lens" option.

Selector Switch Operators, Non-Illuminated



800FD – S L 3 2 X 11
a *b* *c*

Operator Function	
Code	Description
M2	Maintained, 2-position
L2	Return from left, 2-position
R2	Return from right, 2-position
M3	Maintained, 3-position
L3	Return from left, 3-position
R3	Return from right, 3-position
B3	Return from both, 3-position

Termination Style	
Code	Description
X	Standard screw
R	Ring lug

Contact Module		
Code	Number of N.O.	Number of N.C.
01‡	0	1
10‡	1	0
11	1	1
02	0	2
20	2	0

‡ Only available for 2-position selector switch.

2-Position Selector Switch				
Knob Position	↙		↘	
	Left	Right	Left	Right
01	X	—	O	—
10	—	O	—	X
11	X	O	O	X
02	X	X	O	O
20	O	O	X	X

3-Position Selector Switch						
Knob Position	↙		↑		↘	
	Left	Right	Left	Right	Left	Right
11	O	O	X	O	X	X
02	O	X	X	X	X	O
20	X	O	O	O	O	X

Note: X = Closed/O = Open

Note: X = Closed/O = Open

2-Position Push-Pull/Twist-to-Release Mushroom Operators, Non-Illuminated§Δ



800FD – MT4 4 X 11
a *b* *c*

Color Cap	
Code	Description
2	Black
3	Green
4	Red
4E	Red - EMO
5	Yellow
6	Blue

Termination Style	
Code	Description
X	Standard screw
R	Ring lug

Contact Module★		
Code	Number of N.O.	Number of N.C.
01	0	1
11	1	1
02	0	2

★ E-stops must contain at least one N.C. circuit.

§ All E-stop operators are EN/ISO 13850 compliant when using at least one N.C. contact block.

Δ E-Stop operators, latch, and contact block combinations have been third-party tested for B10d values. B10d values can be found in publication SAFETY-SR001_-EN-E.

Specifications★

Mechanical Ratings				
Vibration (assembled to panel)	Tested at 10...2000 Hz, 1.52 mm displacement (peak-to-peak) max./10 G max. for 3 hr duration, no damage			
Shock	Tested at 1/2 cycle sine wave for 11 ms; no damage at 100 G			
Degree of protection	IP66 (Type 3/3R/4/4X/12/13)			
Mechanical durability per EN 60947-5-1 (Annex C)	300 000 cycles	Selector switch		
	2 000 000 cycles	Push-pull/twist-to-release E-stop Momentary push buttons		
Operating forces	E-stop = 36 N			
Operating torque (typical application with one contact block)	Selector switch = 0.25 N•m			
	N.O.	Slow double make and break		
Contact operation	N.C.	Slow double make and break - positive opening		
		↻		
Push button travel to change electrical state	N.O.	2.5 mm (0.1 in.)		
	N.C.	1.5 mm (0.060 in.)		
Environmental				
Temperature range (operating)	-25...+60 °C (-13...+140 °F)‡			
Temperature range (short term storage)	-40...+85 °C (-40...+185 °F)			
Humidity	50...95% RH from 25...60 °C (77...140 °F)			
Electrical Ratings				
Standard contact block ratings	B300, R300 AC 15, DC 13 300 VAC EN/IEC 60947-5-1 and UL 508, 17V, 5 mA min.			
	Nominal Voltage	Range	Current Draw	Frequency
LED module ratings	24V AC	20...26V AC	32 mA	50/60 Hz
	24V DC	18...30V DC	24 mA	DC
	120V AC	102...132V AC	22 mA	50/60 Hz
	240V AC	204...264V AC	22 mA	50/60 Hz
Thermal current	5 A max. enclosed (40 °C ambient) to UL 508, EN/IEC 60947-5-1			
Insulation voltage (U _i)	300V			
Wire capacity (screw terminal)	#18...14 AWG (0.75...2.5 mm ²) Max. (2) #14 AWG, uses same size wire only			
Recommendations for ring lug termination option§	6.35 mm (0.250 in.) Max. outer diameter with 3.8 mm (0.148 in.) hole diameter			
Recommended tightening torque on screw terminals	0.7...0.9 N•m (6...8 lb•in)			
Dielectric strength (minimum)	2500V for one minute			
External short circuit protection	5 A Type gL/gG cartridge fuse to EN 60269-2-1 or gN (Class J to UL 248-8 or Class CC to UL 248-4)			
Electrical shock protection	Finger-safe conforming to IP2X			
Illumination				
LED dominant wavelength	Green	525 nm		
	Red	629 nm		
	Yellow	590 nm		
	Blue	470 nm		
	White	—		
LED luminous intensity	Green	780 mcd		
	Red	780 mcd		
	Yellow	600 mcd		
	Blue	168 mcd		
	White	360 mcd		
Incandescent maximum wattage	2.6 W			

★ Performance Data — see note on page 3.

‡ Operating temperatures below 0 °C (32 °F) are based on the absence of freezing moisture and liquids.

§ 3M MV018-R/S (#22...18 AWG) or 3M MVU14-6R/S (#16...14 AWG)

Specifications, Continued

Materials			
Springs	Stainless steel and zinc coated music wire	Lens (pilot light)	Acrylic
Electrical contacts	Brass with silver-nickel contacts	Bezel/bushing, housing	Glass-filled polyester
Terminals	Brass and phosphor bronze	Legend frames	Glass-filled polyamide
Panel gasket	Nitrile and polyester-based TPE	Mounting ring	Glass-filled polyamide
Seal	Nitrile	Terminal screws	Zinc-plated steel with chromate
Button cap/mushroom head	Polyester/polycarbonate blend	Lamp socket	Brass and Phosphor bronze

★ Performance Data — see note on page 3.

Standards Compliance and Certifications

Certifications	UL, CSA, CCC, CE
Conformity to standards — CE Marked	UL 508, EN/ISO 13850, EN 60947-1, EN 60947-5-1, EN 60947-5-2
Terminal identification	EN/IEC 60947-1

Approximate Dimensions

Dimensions in millimeters. Dimensions are not intended to be used for manufacturing purposes. Refer to RAISE software for additional dimensional information.

Momentary Push Button Operators — Flush

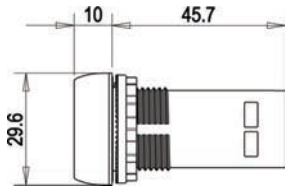

Momentary Push Button Operators — Extended

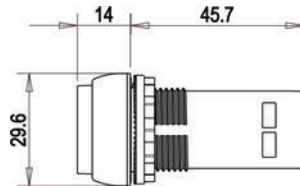

Pilot Light Devices

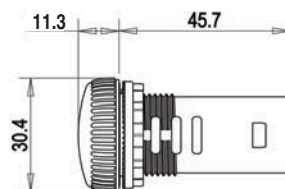

2-Position Push-Pull/Twist-to-Release Mushroom Operators

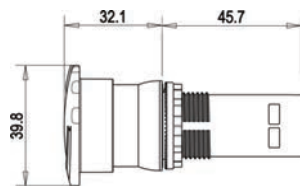

Selector Switch Operators

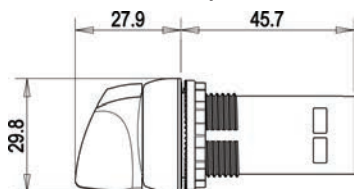

Plastic Enclosures

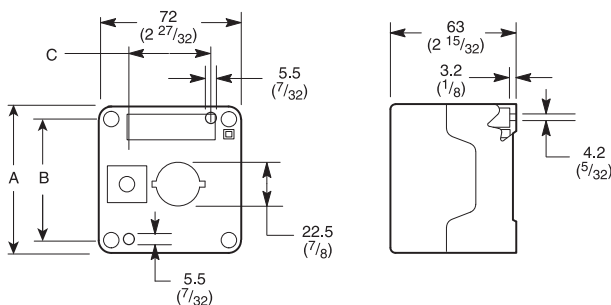

Instruction Sheet

OPTION WAHL OPZIONE OPÇÃO OPCION

(A)							
(A)							
(B)							
	30	40	50	40	50	60/90	
	30			40		60/90	

PLASTIC PLASTIQUE PLASTIK PLASTICA PLÁSTICO } 1.7 Nm 15 lb-in

Use the same size wire only
Utiliser uniquement du fil de même dimension
Nur Draht derselben Größe verwenden
utilizzare solo cavi della stessa dimensione
use somente fios do mesmo tamanho
usar sólo el mismo tamaño de cable

0.75 - 1.5 mm² (#18 - #14 AWG)

0.7 - 0.9 Nm 6 - 8 lb-in

or ou oder o

“R” option for ring connectors
option de “R” pour cosses à plage ronde
“R” Wahl für Ringkabelschuhe
opzione “R” per capicorda ad anello
opção de “R” para conectores do anel
opción de “R” para los conectores del anillo

Plastic Enclosures

Cat. No.	No. of Units (Holes)	A	B	C	Weight
800FD-1P	1	72	59	41	95 g
800FD-1PY	1	(2-27/32)	(2-5/16)	(1-5/8)	(3.5 oz)

Specifications

Mechanical Ratings		
Vibration (assembled to panel)	Tested at 10...2000 Hz, 1.52 mm displacement (peak-to-peak) max./10 G max. for 6 hr duration, no damage	
Shock	Tested at 1/2 cycle sine wave for 11 ms; no damage at 100 G	
Degree of protection‡	IP66, Type 4/4X/13	
Mechanical durability per EN 60947-5-1 (Annex C)	2 000 000 Cycles	Push buttons – momentary
	1 000 000 Cycles	Push buttons – maintained
	250 000 Cycles	Selector switch
	200 000 Cycles	Key selector switch
	200 000 Cycles	Twist-to-release E-stop
Operating forces (typical with one contact block)	Extended = 5...8 N E-stop = 14...16 N	
Operating torque (typical application with one contact block)	Selector switch = 0.06 N•m (0.5 lb•in)	
Mounting torque	1.1 N•m (10 lb•in)	
Environmental		
Temperature range (operating)	-25...+55 °C (-13...+131 °F)	
Temperature range (short term storage)	-40...+70 °C (-40...+158 °F)	
Humidity	50...95% RH from 25...60 °C (77...140 °F)	

‡ Keyed selector switches do not meet 4X rating.

Mechanical Ratings — Contact Blocks		
Vibration (assembled to panel)	Tested at 10...2000 Hz, 1.52 mm displacement (peak-to-peak) max./10 G max. 6 hr	
Shock	Tested at 1/2 cycle sine wave for 11 ms and no damage at 100 G max.	
Contact durability	200 000 cycles (Cat. No. 800B-PS_)	
Contact operation	N.O. / N.C.	Snap action
	N.C.	Slow make/break positive opening ↶
	N.O.	Slow make/break
Push button travel to change electrical state	1.4 mm (0.06 in.)	
Operating forces (typical)	1 contact block = 3 N 2 contact blocks = 6 N	

Electrical Ratings			
Standard contact block ratings	AC 15, B300, 1.5 A/240V AC, 3 A/120V AC DC 13, R300, 0.1 A/250V DC, 0.22 A/125V DC		
LED Module ratings	Nominal Voltage	Current	Frequency
	12...24V AC	12 mA	50/60 Hz
	12...24V DC	12 mA	DC
	120V AC	9 mA	50/60 Hz
Thermal current	$I_{th} = 5 \text{ A (AC)}, I_{th} = 1 \text{ A (DC)}$		
Insulation voltage (U _i)	300V		
Stab termination	2.8 X 0.5 mm		
Dielectric strength (minimum)	1500V 1 min.		
External short circuit protection – standard blocks	6 A type gL/gG cartridge fuse to EN 60269-2-1 or gN (Class J to UL 248-8 or Class C to UL 248-4)		
Electrical shock protection	Finger-safe conforming to IP2X		

Illumination		
LED Dominant wavelength	Green	525 nm
	Red	624 nm
	White	—
LED Luminous intensity	Green	500 mcd
	Red	400 mcd
	White	1000 mcd
Incandescent maximum wattage	1.2 W	
Materials		
Springs	Stainless steel and gold-plated, high-carbon steel	
Electrical contacts	Gold-plated silver	
Stab terminals	Phosphor bronze with gold or nickel plating	
Lenses	Polycarbonate	

Standards Compliance and Certifications

Certifications	UR, CSA, CCC, CE
Standards Compliance	UL 508, EN ISO 13850, EN 60947-1, EN 60947-5-1, EN 60947-5-5
Terminal Identification	EN/IEC 60947-1
RoHS Compliant	✓

Operator Assembly Sequence



★ Optional

Target Table and Operator Position

Contact Block Cat. No.	Contact Block Location	Contact Type	2-Position Target Table		3-Position Target Table		
			↙	↘	↙	↕	↘
800B-PS11	Top	NA	—	—	—	—	—
	Bottom	N.C.	X	O	O	X	X
		N.O.	O	X	X	O	O
800B-PS22	Top	N.C.	X	O	X	X	O
		N.O.	O	X	O	O	X
	Bottom	N.C.	X	O	O	X	X
		N.O.	O	X	X	O	O
800B-PT01	Top	NA	—	—	—	—	—
	Bottom	N.C.	X	O	O	X	X
800B-PT02	Top	N.C.	X	O	X	X	O
	Bottom		X	O	O	X	X
800B-PT11	Top	N.O.	O	X	O	O	X
	Bottom	N.C.	X	O	O	X	X

Note: X = Closed/O = Open

Note: To illuminate a selector switch, add either an LED or incandescent bulb. All selector switches have a clear lens. Green and red LED bulbs can be used to change the selector switch color.

Approximate Dimensions

Round

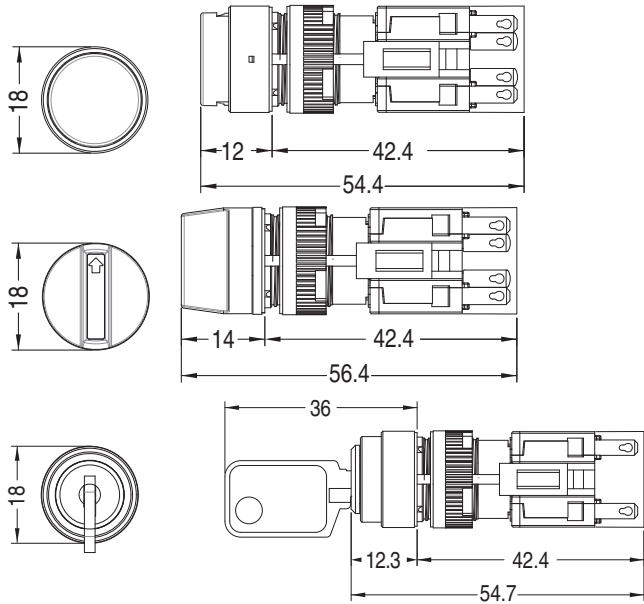

Hole Patterns

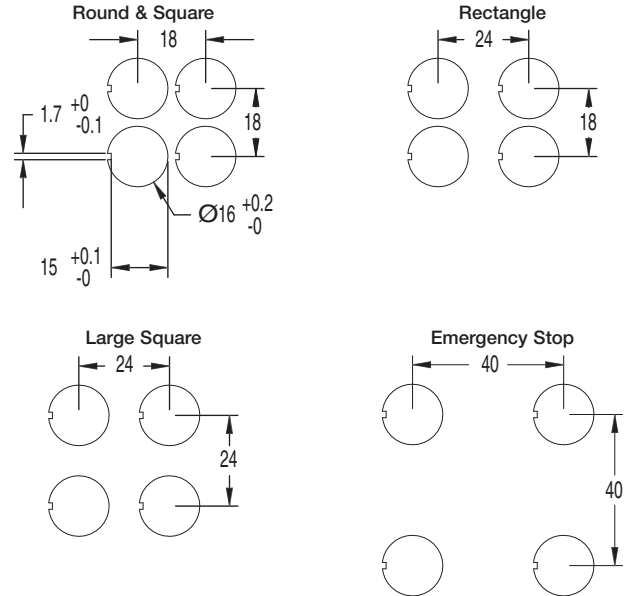

Square

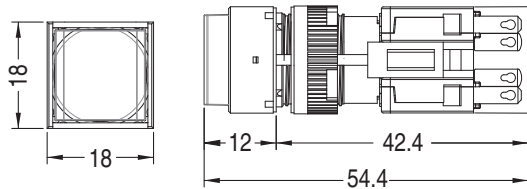

Printed Circuit Board Pin Socket

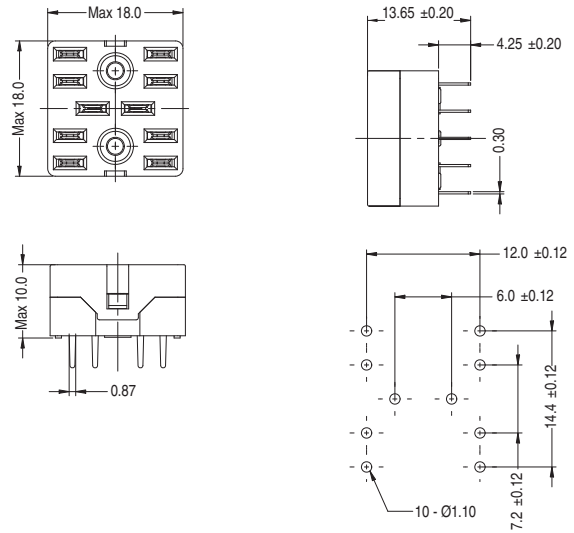

Rectangle

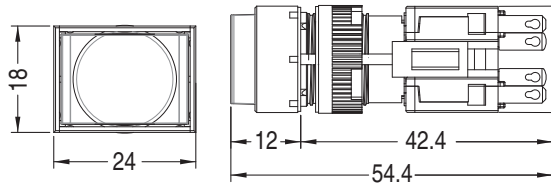

Large Square

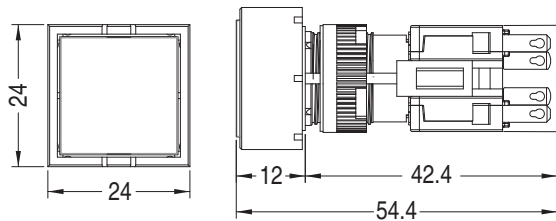

Emergency Stop

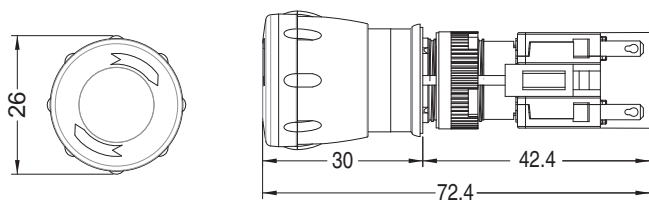

Bul. 800MR - Momentary Contact Push Buttons

Momentary Contact Push Button Units, Non-Illuminated



Flush Head Unit
Cat. No. 800MR-A1B



Extended Head Unit
Cat. No. 800MR-B2A



Mushroom Head Unit
Cat. No. 800MR-D2B

800MR – A 1 A
 a b c d

a

Operator Type★	
Code	Description
A	Flush head
B	Extended head
D	Mushroom head

b

Button Color	
Code	Description
1	Green
2	Black
3	Orange
4	Grey
5	White
6	Red
7	Blue
9	Yellow

c

Standard Contact Cartridges	
Code	Description
Blank	No contacts
A	1 N.O. - 1 N.C.
A2	2 N.O.
A3	1 N.O.E.M. - 1 N.C.L.B.
A4	2 N.C.
A7	1 N.C.L.B. - 1 N.C.
B	2 N.O. - 2 N.C.
D1	1 N.O.
D2	1 N.C.

d

Contact Block Termination Type‡	
Code	Description
Blank	Stab terminals
K	Large screw

★ Guards must be ordered separately.
‡ Logic Reed and small screw blocks can be ordered separately.

Momentary Contact Push Button Units, Illuminated



Flush Head Unit
Cat. No. 800MR-QA24GA



Extended Head Unit
Cat. No. 800MR-PB16RA



Mushroom Head Unit
Cat. No. 800MR-QMB24RA

800MR – PA L 24 R
a b c d e f

a

Operator	
Transformer	
Code	Description
PA	Flush ♦
PB	Extended
PMB	Mushroom
Full Voltage	
Code	Description
QA	Flush ♦
QB	Extended
QMB	Mushroom

b

Illumination Options	
Code	Description
Blank	Standard illumination as determined by power module type
L	LED§

c

Input Voltage	
Full Voltage	
Code	Description
12	12V AC/DC
24	24V AC/DC
10	120V AC♣
Transformer	
Code	Description
16	120V AC 50/60 Hz
26	240V AC 50/60 Hz

d

Lens Color	
Code	Color
A	Amber
B	Blue
C	Clear
G	Green
R	Red
W	White
X	No lens with contact blocks
Blank	No lens without contact blocks

e

Standard Contact Cartridges	
Code	Description
Blank	No contacts
A	1 N.O. - 1 N.C.
A2	2 N.O.
A3	1 N.O.E.M. - 1 N.C.L.B.
A4	2 N.C.
A7	1 N.C.L.B. - 1 N.C.
B	2 N.O. - 2 N.C.Δ
D1	1 N.O.
D2	1 N.C.

f

Contact Block Termination Type♣	
Code	Description
Blank	Stab terminals
K	Large screw

§ LEDs available in red, green, amber, blue, and white. LED color must match lens color, except clear lens supplied with white LED and white lens supplied with amber LED.

♣ Only available with LED Illumination option.

Δ Only available with full voltage power module option and standard stab terminations.

♦ Guards must be ordered separately.

♣ Logic Reed and small screw blocks must be ordered separately.

Bul. 800MR - Push-Pull

2-Position Push-Pull and Push-Pull/Twist Release and 3-Position Push-Pull Units, Non-Illuminated



2-Position Push-Pull
Cat. No. 800MR-FX6A



2-Position Push-Pull/Twist
Cat. No. 800MR-FXT6A4

800MR – FX T 6 A (2-Position)
 a b c d e f

800MR – FX N 6 A (3-Position)
 a b₁ c d e f

a

Operator Type	
Code	Description
FX	Push-pull unit

c

Operator	
Code	Color
Blank	Non-illuminated

e

Contact Cartridges	
Code	Description
Blank	No contacts
A	1 N.O. - 1 N.C.
A2	2 N.O.
A4	2 N.C.
A7	1 N.C.L.B. - 1 N.C.
B	2 N.O. - 2 N.C.
D1	1 N.O.
D2	1 N.C.

Note: See Table 1 for Target description.



b

Operator Function	
2-Position	
Code	Description
Blank	Maintained — push-pull
T	Twist-release

d

Button Color	
Code	Color
1	Green
2	Black
3	Orange
4	Grey
5	White
6	Red
7	Blue
9	Yellow
Blank	No cap





b₁

Operator Function			
3-Position*			
Code	Operator Position		
			
	Out	Center	In
N	Momentary	Maintained	Momentary

f

Contact Block Termination Type†	
Code	Description
Blank	Stab terminals
K	Large screw

Table 1. Target Selection

Code	2-Position		Contact Description	3-Position			Code
							
	Out	In		Out	Center	In	
Blank	—	—	No contacts	—	—	—	Blank
D1	O	X	N.O.	—	—	—	—
D2	X	O	N.C.	—	—	—	—
A	O X	X O	N.O. - N.C.	O X	O O	X O	A
A2	O O	X X	N.O. - N.O.	O O	O O	X X	A2
A4	X X	O O	N.C. - N.C.	X X	O O	O O	A4
—	—	—	N.C. - N.C.L.B.	X X	O X	O O	A7
B	O X O X	X O X O	N.O. - N.C. N.O. - N.C.	O X O X	O O O O	X O X O	B

Note: X = Closed/O = Open

* Not available in twist release.

† Logic Reed and small screw blocks must be ordered separately.

2-Position Push-Pull and Push-Pull/Twist Release and 3-Position Push-Pull Units, Illuminated



Illuminated 2-Position Push-Pull
Cat. No. 800MR-FXQ24RA



Illuminated 2-Position Push-Pull/Twist
Cat. No. 800MR-FXTP16RA

800MR – FX T P 16 R A (2-Position)

a *b* *c* *d* *e* *f* *g* *h*

800MR – FX N P 16 R A (3-Position)

a *b*₁ *c* *d* *e* *f* *g* *h*

a

c

f

Operator Type	
Code	Description
FX	Push-pull unit

b

Operator Function	
2-Position	
Code	Description
Blank	Maintained
T	Twist-release

*b*₁

Operator Function			
3-Position			
Code	Operator Position		
	Out	Center	In
N	Momentary	Maintained	Momentary

Operator Type	
Code	Description
P	Transformer
Q	Full voltage

d

Illumination Options	
Code	Description
Blank	Incandescent lamp
L	LED†

e

Voltage	
Full Voltage	
Code	Description
12	12V AC/DC
24	24V AC/DC
10	120V AC§
Transformer	
Code	Description
16	120V AC 50/60 Hz
26	240V AC 50/60 Hz

Button Color	
Code	Color
A	Amber
B	Blue
C	Clear
G	Green
R	Red
W	White★
X	No cap

g

Contact Cartridges	
Code	Description
Blank	No contacts
A	1 N.O. - 1 N.C.
A2	2 N.O.
A4	2 N.C.
A7	1.N.C.L.B. - 1 N.C.
B	2 N.O. - 2 N.C.‡
D1	1 N.O.
D2	1 N.C.

Note: See Table 1 for Target description.

Table 2. Target Selection

Code	2-Position		Contact Description	3-Position			Code
	Out	In		Out	Center	In	
Blank	—	—	No contacts	—	—	—	Blank
D1	O	X	N.O.	—	—	—	—
D2	X	O	N.C.	—	—	—	—
A	O X	X O	N.O. - N.C.	O X	O O	X O	A
A2	O O	X X	N.O. - N.O.	O O	O O	X X	A2
A4	X X	O O	N.C. - N.C.	X X	O O	O O	A4
—	—	—	N.C. - N.C.L.B.	X X	O X	O O	A7
B	O X O X	X O X O	N.O. - N.C. N.O. - N.C.	O X O X	O O O O	X O X O	B

Note: X = Closed/O = Open

★ Not available in twist release.

‡ LEDs available in red, green, amber, blue, and white. LED color must match lens color, except clear lens supplied with white LED and white lens supplied with amber LED.

§ Only available with LED Illumination option.

‡ Only available with full voltage power module option and standard stab terminations.

Δ Logic Reed and small screw blocks must be ordered separately.

h

Contact Block Termination TypeΔ	
Code	Description
Blank	Stab terminals
K	Large screw

Bul. 800MR - Selector Switches
2-Position Selector Switch Units, Non-Illuminated



Standard Knob Operator
Cat. No. 800MR-HH2BLA

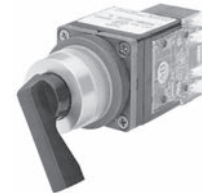

Knob Lever Operator
Cat. No. 800MR-HK2BLA

(Selector Switch)

800MR – H H 2 B L A
a *b* *c* *d* *e* *e₁* *f*

800MR – H 31 B L A (Cylinder Lock)
a *b* *c₁* *c₂* *d* *e* *e₁* *f*

a

Operator Positions	
Code	Description
H	2-position selector switch
H	2-position cylinder lock

b

Operator Color and Type§	
Standard Knob	
Code	Description
X	No knob
H	Black
Knob Lever	
Code	Description
X	No knob lever
K	Black
Cylinder Lock	
Code	Description
Blank	Key

c

Operator Function	
Standard Knob	
Code	Description
2	Maintained
4	Spring return from left
5	Spring return from right

c₁

Operator Function/Locking Position★	
Maintained	
Code	Description
31	Lock in left
32	Lock in right
33	Lock in both
Spring Return From Left	
Code	Description
42	Lock in right
Spring Return From Right	
Code	Description
48	Lock in left

c₂

Key Codes‡		
Code	Key No.	Master Key
Blank	T100 (standard)	1T
02	T101	1T
03	T102	1T
04	T106	1T
05	T107	1T
07	T109	2T
08	T134	2T
09	T135	2T
10	T136	2T
14	T147	2T

d

Cam Type	
Code	Description
B	B cam

e

Contact Cartridge Position	
Code	Description
Blank	Both left and right
L	Left

e₁

Contact Cartridges	
Code	Description
Blank	No contacts
Δ A	1 N.O. - 1 N.C.
Δ A2	2 N.O.
Δ A4	2 N.C.
◆ B	2 N.O. - 2 N.C.
Δ D1	1 N.O.
Δ D2	1 N.C.
◆ P1	3 N.O.
◆ P2	3 N.C.
◆ P3	2 N.O. - 1 N.C.
◆ P4	2 N.C. - 1 N.O.
◆ P5	4 N.O.
◆ P6	4 N.C.
◆ P7	3 N.O. - 1 N.C.
◆ P8	1 N.O. - 3 N.C.

Note: See Table 1 for Target arrangements

f

Contact Block Termination Type*	
Code	Description
Blank	Stab terminals
K	Large screw

Table 1. Selector Switch Cam Targets

Cam Description (2-Position)			
Target		Operator Function	
		Maintained and Spring Returned From Right	Spring Returned From Left
X	O	N.C.	N.O.
O	X	N.O.	N.C.

Note: X = Closed/O = Open

★ Key removable in locked position only.

‡ If no optional key code is specified, the standard key (T100) will be supplied.

§ Red, green, blue, yellow, orange, grey, and white non-illuminated selector switch knobs and lever knobs must be ordered separately.

♣ Logic Reed and small screw contact blocks must be ordered separately.

Δ Contact cartridge position code (Table e) must be L.

◆ Contact cartridge position code (Table e) must be --.

3-Position Selector Switch Units, Non-Illuminated



Standard Knob Operator
Cat. No. 800MR-JH2BB



Knob Lever Operator
Cat. No. 800MR-JK2BB

800MR – J H 2 B L A _____
 a b c d e e₁ f

(Selector Switch)

800MR – J _____ 41 _____ B L A _____
 a b c₁ c₂ d e e₁ f

(Cylinder Lock)

a

c₂

e₁

Operator Positions	
Code	Description
J	3-position selector switch
J	3-position cylinder lock

b

Operator Color and Type§		
Standard Knob	Description	Knob Lever
Code		Code
X	No knob	X
H	Black	K
Blank	Key	Blank

c

Operator Function	
Code	Description
2	Maintained
4	Spring return from left
5	Spring return from right
9	Spring return from both

c₁

Operator Function/Locking Position★	
Maintained	
Code	Description
41	Lock in left
42	Lock in center
43	Lock in right
44	Lock in all positions
45	Lock in left and center
46	Lock in right and left
47	Lock in right and center
Spring Return From Left	
Code	Description
50	Lock in center
52	Lock in right
51	Lock in right and center
Spring Return From Right	
Code	Description
69	Lock in left
38	Lock in center
73	Lock in left and center
Spring Return From Left and Right	
Code	Description
631	Lock in center★

Key Codes‡	
1T Master Series	
Code	Key No.
Blank	T100 (standard)
02	T101
03	T102
04	T106
05	T107
2T Master Series	
Code	Key No.
07	T109
08	T134
09	T135
10	T136
14	T147

d

Cam Type	
Code	Description
B	B cam
K	K cam
P	P cam
U	U cam

e

Contact Cartridge Position	
Code	Description
Blank	Both left and right
L	Left
R	Right

Contact Cartridges		
Standard	Description	
Code	Left side	Right side
Blank	No contacts	
Δ A	1 N.O.-1 N.C.	
Δ A3	1 N.O.E.M.-1 N.C.L.B.	
♦ B	1 N.O.-1 N.C.	
♦ P1	2 N.O.	1 N.O.
♦ P2	2 N.C.	1 N.C.
♦ P3	2 N.O.	1 N.C.
♦ P4	2 N.C.	1 N.O.
♦ P5	2 N.O.	2 N.O.
♦ P6	2 N.C.	2 N.C.
♦ P7	2 N.O.	1 N.O. - 1 N.C.
♦ P8	2 N.C.	1 N.O. - 1 N.C.
♦ P9	1 N.O.	1 N.C.
♦ T1	1 N.O. - 1 N.C.	1 N.C.

f

Contact Block Termination Type♣	
Code	Description
Blank	Stab terminals
K	Large screw

Note: See Table 1 for cam and contact block selection.

★ Key removable in locked position only.

‡ If no optional key code is specified, the standard key (T100) will be supplied.

§ Red, green, blue, yellow, orange, grey, and white non-illuminated selector switch knobs and lever knobs must be ordered separately.

♣ Logic Reed and small screw contact blocks must be ordered separately.

Δ Contact cartridge position code (Table e) must be L or R.

♦ Contact cartridge position code (Table e) must be --.

Table 1. Selector Switch Cam Targets

Note: X = Closed/O = Open				Cam Description						
Target		B		K		P		U		
↻	↑	Left Side	Right Side	Left Side	Right Side	Left Side	Right Side	Left Side	Right Side	
O	O	X	N.O.	N.O.	N.O.	—	N.O.	—	—	N.O.
X	O	O	N.C.	N.C.	—	N.O.	N.C.	N.O.	N.O.	—
O	X	X	N.O.E.M.	N.O.E.M.	—	N.C.L.B.	N.O.E.M.	N.C.L.B.	N.C.	—
X	X	O	N.C.L.B.	N.C.L.B.	N.C.L.B.	—	N.C.L.B.	—	—	N.C.
O	X	O	—	—	N.C.	N.C.	—	N.C.	—	—

4-Position Selector Switch Units, Non-Illuminated



Standard Knob Operator
Cat. No. 800MR-NH2QB



Knob Lever Operator
Cat. No. 800MR-NK2QB

800MR – N H 2 Q B _____ (Selector Switch)
 a b c d e f

800MR N _____ 31 _____ Q B _____ (Cylinder Lock)
 a b c₁ c₂ d e f

a

Operator Positions	
Code	Description
N	4-position selector
N	4-position cylinder lock

b

Operator Color and Type*		
Standard Knob	Description	Knob Lever
Code		Code
X	No knob	X
H	Black	K
Blank	Key	Blank

c

Operator Function‡	
Code	Description
2	Maintained

c₁

Operator Function/Locking Position*	
Standard Key	
Code	Description
31	Lock in position 1
32	Lock in position 2
33	Lock in position 3
34	Lock in position 4
41	Lock in position 1-2
42	Lock in position 1-3
43	Lock in position 1-4
44	Lock in position 2-3
45	Lock in position 2-4
46	Lock in position 3-4
51	Lock in position 1-2-3
52	Lock in position 1-2-4
53	Lock in position 1-3-4
54	Lock in position 2-3-4
61	Lock in all positions

c₂

Key Codes§		
Code	Key No.	Master Key
Blank	T100 (standard)	1T
02	T101	1T
03	T102	1T
04	T106	1T
05	T107	1T
07	T109	2T
08	T134	2T
09	T135	2T
10	T136	2T
14	T147	2T

d

Cam Type and Target Table					
Q				Contact Type (Rear View)	
Target				Left	Right
				1 N.O.	—
O	O	O	X	1 N.C.	—
O	X	O	O	—	1 N.O.
X	O	O	O	—	1 N.C.

Note: X = Closed/O = Open

e

Contact Cartridges	
Standard Block/Stab Terminations	
Code	Description
Blank	No contacts
B	2 N.O. - 2 N.C.

f

Contact Block Termination TypeΔ	
Code	Description
Blank	Stab terminals
K	Large screw

- * Red, green, blue, yellow, orange, grey, and white non-illuminated selector switch knobs and knob levers must be ordered separately.
- * Key removable in locked position only.
- ‡ Operators are maintained in all positions.
- § If no optional key code is specified, the standard key (T100) will be supplied.
- Δ Logic Reed and small screw contact blocks must be ordered separately.

2-Position and 3-Position Knob/Lever Type Selector Switch Units, Illuminated



800MR - 24 a b c d e f g₁ g₂ h

Input Voltage	
Full Voltage	
Code	Description
12	12V AC/DC
24	24V AC/DC
10	120V AC★
Transformer	
Code	Description
16	120V AC 50/60 Hz
26	240V AC 50/60 Hz

Operator Positions	
Code	Description
H	2-position
J	3-position

Operator Color and Type		
Standard Knob	Description	Knob Lever
Code		Code
X	No knob	X
A	Red	L
B	Green	M
D	Amber	P
Y	Clear	Z

Illumination Options	
Code	Description
Blank	Incandescent
L	LED‡

Operator Function	
Code	Description
2	Maintained
4	Spring return from left
5	Spring return from right
9	Spring return from both

Cam Type (2-Position)	
Code	Description
B	B cam

Note: For Target arrangements see Table 1.

Cam Type (3-Position)	
Code	Description
B	B cam
K	K cam
P	P cam
U	U cam

Note: For Target arrangements see Table 2.

Contact Cartridges			
		Description	
Code	Left side	Right side	
Blank	No contacts		
Δ	A	—	1 N.O.-1 N.C.
Δ▲	A2	—	2 N.O.
Δ	A3	—	1 N.O.E.M.-1 N.C.L.B.
Δ▲	A4	—	2 N.C.
§♦	B	1 N.O.-1 N.C.	1 N.O.-1 N.C.
Δ▲	D1	—	1 N.O.
Δ▲	D2	—	1 N.C.
§♦	P1	2 N.O.	1 N.O.
§♦	P2	2 N.C.	1 N.C.
§♦	P3	2 N.O.	1 N.C.
§♦	P4	2 N.C.	1 N.O.
§♦	P5	2 N.O.	2 N.O.
§♦	P6	2 N.C.	2 N.C.
§♦	P7	2 N.O.	1 N.O.-1 N.C.
§♦	P8	2 N.C.	1 N.O.-1 N.C.
§♦	P9	1 N.O.	1 N.C.
§♦	T1	1 N.O.-1 N.C.	1 N.C.

Note: See Table 1 for 2-position contact block selection. See Table 2 for 3-position contact block selection.

Contact Block Termination Type*	
Code	Description
Blank	Stab terminals
K	Large screw

Table 1. Selector Switch Cam Targets

Cam Description (2-Position)			
B			
Target	Operator Function		
		Maintained and Spring Return From Right	Spring Return From Left
X	O	N.C.	N.O.
O	X	N.O.	N.C.

Note: X = Closed/O = Open

Table 2. Selector Switch Cam Targets

Cam Description (3-Position)										
Target			B		K		P		U	
			Left Side	Right Side	Left Side	Right Side	Left Side	Right Side	Left Side	Right Side
O	O	X	N.O.	N.O.	N.O.	—	N.O.	—	—	N.O.
X	O	O	N.C.	N.C.	—	N.O.	N.C.	N.O.	N.O.	—
O	X	X	N.O.E.M.	N.O.E.M.	—	N.C.L.B.	N.O.E.M.	N.C.L.B.	N.C.	—
X	X	O	N.C.L.B.	N.C.L.B.	N.C.L.B.	—	N.C.L.B.	—	—	N.C.
O	X	O	—	—	N.C.	N.C.	—	N.C.	—	—

Note: X = Closed/O = Open

- ★ Only available with LED Illumination option.
- ‡ LEDs only available in red, green, amber and white. Knob color must match LED color, except clear knob supplied with white LED.
- § Only available with full voltage power module and standard stab terminations.
- ▲ Logic Reed and small screw contact blocks must be ordered separately.
- Δ Contact cartridge position code (Table g₁) must be R.
- ♦ Contact cartridge position code (Table g₁) must be --.
- ▲ Only available for 2-position selector switches.

4-Position Knob/Lever Type Selector Switch Units, Illuminated



Standard Knob Operator
Cat. No. 800MR-24NA2QB



Knob Lever Operator
Cat. No. 800MR-24NL2QB

800MR – 24 N A L 2 Q B
a *b* *c* *d* *e* *f* *g* *h*

a

Input Voltage	
Full Voltage	
Code	Description
12	12V AC/DC
24	24V AC/DC
10	120V AC★

b

Operator Positions	
Code	Description
N	4-position‡

c

Operator Color and Type		
Standard Knob	Description	Knob Lever
Code		Code
X	No knob	X
A	Red	L
B	Green	M
D	Amber	P
Y	Clear	Z

d

Illumination Options	
Code	Description
Blank	Incandescent
L	LED§

e

Operator Function	
Code	Standard knob function
2	Maintained

f

Cam Type and Target Table					
Q					
Target				Contact Type (Rear View)	
				Left	Right
O	O	O	X	1 N.O.	—
O	O	X	O	1 N.C.	—
O	X	O	O	—	1 N.O.
X	O	O	O	—	1 N.C.

Note: X = Closed/ O = Open

g

Contact Cartridges	
Standard Block	
Code	Description
B	2 N.O. - 2 N.C.

h

Contact Block Termination Type*	
Code	Description
Blank	Stab terminals

Note: X = Closed/ O = Open

- ★ Only available with LED Illumination option.
- ‡ Operator is maintained in all positions.
- § LEDs only available in red, green, amber and white. Knob color must match LED color, except clear knob supplied with white LED.
- ♣ Logic Reed contact blocks must be ordered separately.

Pilot Light Units



Pilot Light
Cat. No. 800MR-Q24R



Push-to-Test Pilot Light
Cat. No. 800MR-QT24R

800MR – P L 24 R
 a b c d e

a

Operator Transformer	
Code	Description
P	Pilot light
PDT	Pilot light — dual input transformer
PT	Pilot light — push-to-test
Full Voltage	
Code	Description
Q	Pilot light
QT	Pilot light — push-to-test

c

Input Voltage Full Voltage	
Code	Description
12	12V AC/DC
24	24V AC/DC
10	120V AC§
Transformer	
Code	Description
16	120V AC 50/60 Hz
26	240V AC 50/60 Hz

d

Lens Color	
Code	Color
Blank	No lens
A	Amber
B	Blue
C	Clear
G	Green
R	Red
W	White

b

Illumination Options	
Code	Description
Blank	Incandescent
L	LED‡

e

Contact Block Termination Type*	
Pilot Lights	
Code	Description
Blank	Stab terminals
K	Large screw△

Note: If large screw terminations are desired with a dual input transformer, (Cat. No. 800MR-PDT...), configurator space e must be left blank.

- ‡ LEDs available in red, green, amber, blue, and white. LED color must match lens color, except clear lens supplied with white LED and white lens supplied with amber LED.
- § Only available with LED illumination option.
- * Small screw contact blocks must be ordered separately.
- △ Only available with Push-to-test units.

Wobble Stick Units



Wobble Stick Unit
Cat. No. 800MR-M1B

800MR – M1 A
 a b c

a

Operator Type	
Code	Description
M1	Wobble stick

b

Contact Cartridges	
Code	Description
Blank	No contacts
A	1 N.O. - 1 N.C.
B	2 N.O. - 2 N.C.

c

Contact Block Termination Type♦	
Code	Description
Blank	Stab terminals
K	Large screw

♦ Logic Reed and small screw contact blocks must be ordered separately.

Bul. 800MB
Momentary Contact Push Button Units, Non-Illuminated



800 MB – CA 1 A — e

a
b
c
d
e

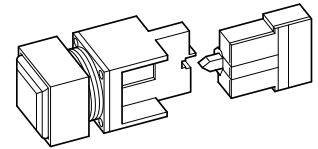

a

Bezel Color†	
Code	Color
MB	Black

b

Operator Type	
Code	Description
CA	Flush head
CB	Extended head

c

Color Insert	
Code	Color
X	No color insert
1	Green
3	Orange
4	Grey
5	White
6	Red★
7	Blue
9	Yellow

d

Contact Block(s)	
Standard	
Code	Description
Blank	No contacts
D1	1 N.O.
D2	1 N.C.
A	1 N.O. - 1 N.C.
A2	2 N.O.
A4	2 N.C.
A7	1 N.C.L.B. - 1 N.C.
B	2 N.O. - 2 N.C.

e

Contact Block Termination Type§	
Code	Description
Blank	Stab terminals
K	Large screw

★ Red flush head must be ordered separately.
 † Grey bezel can be ordered separately.
 § Logic Reed and small screw contact blocks must be ordered separately.

Momentary Contact Push Button Units, Illuminated



Flush Head Unit
Cat. No. 800MB-CPA16GA



Extended Head Unit
Cat. No. 800MB-CQB24RA

800 MB – CQ A L 06 R A _____
 a b c d e f g h

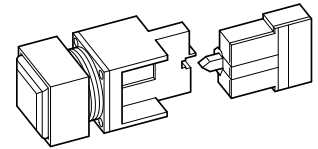

a

Bezel Color†	
Code	Color
MB	Black

b

Power Module Type	
Code	Description
CQ	Full voltage
CP	Transformer

c

Operator Type	
Code	Description
A	Flush
B	Extended

d

Illumination Options	
Code	Description
Blank	Incandescent
L	LED§*

e

Voltage	
Full Voltage	
Code	Description
12	12V AC/DC
24	24V AC/DC
10	120V AC△
Transformer	
Code	Description
16	120V AC
26	240V AC

f

Color Insert	
Code	Color
Blank	No contacts
X	Packet of colored inserts◆
A	Amber
B	Blue
C	Clear
G	Green
R	Red★

g

Contact Block(s)	
Standard	
Code	Description
Blank	No contacts
D1	1 N.O.
D2	1 N.C.
A	1 N.O. - 1 N.C.
A2	2 N.O.
A4	2 N.C.
A7	1 N.C.L.B. - 1 N.C.
B	2 N.O. - 2 N.C.▲

h

Contact Block Termination Type▽	
Code	Description
Blank	Stab terminals
K	Large screw

★ Red flush head push buttons are not suitable for applications requiring extended head or other unguarded buttons capable of being operated quickly in emergencies, and they may not comply with applicable codes or standards.

† Grey bezels can be ordered separately.

§ LEDs are only available in red, green, amber, and white; lens color must match LED color.

▲ White LED available in 24V AC/DC only.

△ LED only.

◆ Packet of colored inserts, one of each color. Not available with LED option for illuminated devices.

▲ Only available with full voltage illumination option and standard stab terminations.

▽ Logic Reed and small screw contact blocks must be ordered separately.

Pilot Light Units



Pilot Light
Cat. No. 800MB-CQ24RS



Push-to-Test Pilot Light
Cat. No. 800MB-CPT16G

800 MB – CP L 24 R

a
b
c
d
e
f

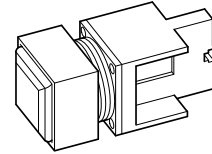

a

Bezel Color*	
Code	Color
MB	Black

b

Power Module Type	
Code	Description
CP	Transformer
CQ	Full voltage

c

Illumination Options	
Code	Description
Blank	Incandescent
L	LED*
T	Push-to-test
TL	Push-to-test with LED*

d

Voltage	
Full Voltage	
Code	Description
12	12V AC/DC
24	24V AC/DC
10	120V AC§
Transformer	
Code	Description
16	120V AC
26	240V AC

e

Lens Color	
Code	Color
X	Packet of colored inserts*
A	Amber
B	Blue
C	Clear/white
G	Green
R	Red

f

Termination Type∇	
Pilot Lights	
Code	Description
Blank	Stab terminals
Push-to-Test Pilot Lights	
Code	Description
Blank	Stab terminals
K	Large screw△

★ LEDs are only available in red, green, amber, and white; lens color must match LED color.
 § LED only.
 * Packet of colored inserts, one of each color. Not available with LED illumination option.
 △ Only available with full voltage power module and standard stab terminations.
 ▲ Grey bezel can be ordered separately.
 ∇ Small screw contact blocks must be ordered separately.

Specifications★

Electrical Ratings		
Contact Ratings	Refer to the Contact Ratings tables below.	
Dielectric Strength	1600V for one minute 1300V for one minute (Logic Reed)	
Electrical Design Life Cycles	750 000 at maximum rated load 200 000 at maximum rated load (Logic Reed)	
Mechanical Ratings		
Vibration	10...2000 Hz 1.52 mm displacement (peak-to-peak) Max./10 G Max. (except Logic Reed)	
Shock	1/2 cycle sine wave for 11 milliseconds \geq 25 G (contact fragility) and no damage at 100 G	
Degree of Protection	Type 13; IEC I44 IP65 Oiltight	
Mechanical Design Life Cycles		
Push Buttons	1 000 000 minimum	
Potentiometers	100 000 minimum	
All other devices	200 000 minimum	
Contact Operation	Contact blocks with Bifurcated spanner:Slow make and break, simple break. Logic Reed Contact Blocks:Snap-action	
Typical Operating Forces		
Operators without contact blocks	2.45 lb (10.8 N)	
Push-Pull Units	8 lb (35.3 N) push to in position 4 lb (17.7 N) maximum pull to out position	
Contact Blocks	Standard — 1.5 lb (6.7 N) Logic Reed — 0.616 lb (2.6 N)	
Environment		
Temperature Range	Operating	32...131 °F (0...55 °C)
	Storage	-40...+185 °F (-40...+85 °C)
Note: Operating temperatures at +32 °F (0 °C) are based on the absence of freezing moisture and liquids.		
Humidity	50% at 104 °F (40 °C)	
Panel Thickness Requirements	1/16...1/4 in. (1.6...6.4 mm)	

★ Performance Data — see note on page 3.

Certifications

UL Listed —File: E14840,
E10314
Guide: NKCR, NOIV
CSA Certified: LR1234, LR11924
IEC Compliance, IEC 529

Standard Contact Ratings

(IEC 337-1) (NEMA ICS 2-125) Maximum continuous current I^{th} 10 A. Bulletin 800M units have control circuit ratings with 800M contact blocks as follows:

Maximum Operational Volts Ue	Utilization Category		Rated Operational Currents		
	IEC	NEMA	Volts Ue	Make	Break
AC 300	AC-II	A300	120...300	7200 VA	720 VA
			72...120	60 VA	720 VA
			24...72‡	60 A	10 A

‡ For applications below 24V and 24 mA, Logic Reed contacts are recommended.

Logic Reed Contact Ratings

Maximum: 150V AC, 0.15 A, 8 VA and 30V DC, 0.06 A, 1.8 VA. Should only be used with resistive loads.

Wire Capacity

Stab Termination Contact Blocks —

Accepts two 0.110 x 0.032 in. push-on connectors or one 0.250 x 0.032 in. push-on connector.

Small Screw Contact Blocks —

Accepts one #14 or two #16 AWG solid or stranded wires.

Large Screw Termination Contact Blocks —

Accepts two #12 AWG solid or stranded wires.

Approximate Dimensions

Dimensions in inches (millimeters). Dimensions are not intended to be used for manufacturing purposes.

Bul. 800MR Extension in Front of Panel

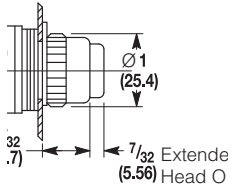

**Round Push Button
Flush, Extended and
Illuminated Extended**

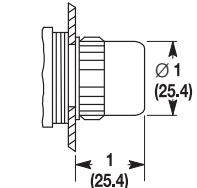

**Round Push Button
Illuminated Flush**

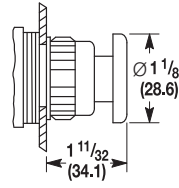

**Round Push Button
Mushroom**

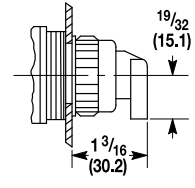

**Round Selector Switch
and Potentiometer
and Standard Knob**

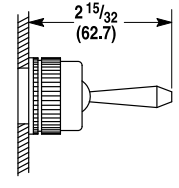

**Panel Wobble
Stick Unit**

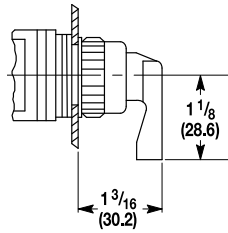

**Round Selector Switch
and Potentiometer
and Wing Lever**

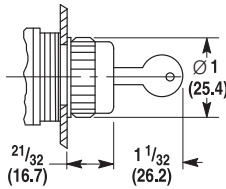

**Round Cylinder Lock
Selector Switch**

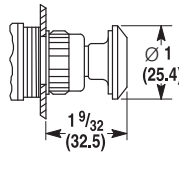

Round Push-Pull

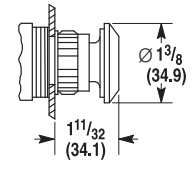

**Twist or Pull
Release Units**

Bul. 800MB Front View of Square Units

CAUTION: To avoid possible excessive heat, clusters of nine or more continuously illuminated units mounted in a small enclosure should be spaced at 1-1/2 in. (38.1 mm) minimum centers in one direction.

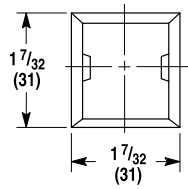

**Unit without Insert
and Backlit Unit**

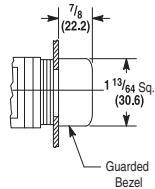

**Square Backlit
with Guarded Bezel**

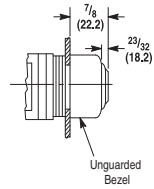

**Square Backlit
with Unguarded Bezel**

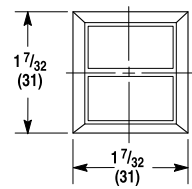

Dual Operator Unit

Bul. 800MB Extension in Front of Panel

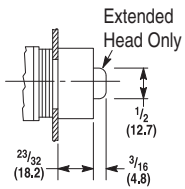

**Square Push Button
Flush and Extended**

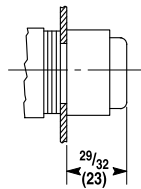

**Square Push Button
Large Extended**

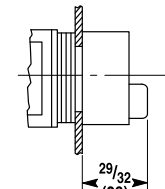

**Square Push Button
Dual Operator**

Dimensions in inches (millimeters). Dimensions are not intended to be used for manufacturing purposes.

Extension Behind Panel

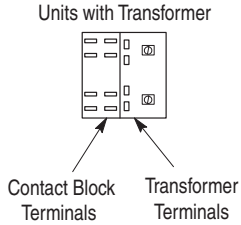
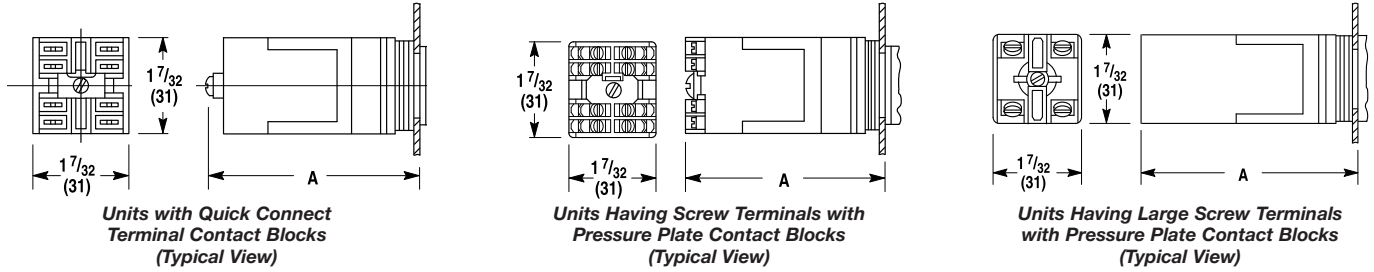

Panel Depth Requirements —

1/16...1/4 in. (1.6...6.4 mm)

Dimension A												
Description	Push Button	Pilot Light	Sel. Switch	Cyl. Lock	Pot.	Push-Pull or Twist Release	Push Button	Pilot Light	Sel. Switch	Cyl. Lock	Pot.	Push-Pull or Twist Release
Non-Illuminated	Units with Quick Connect Terminals						Units Having Small Screw Terminals with Pressure Plates					
	2-1/4 (57.2)	—	2-15/32 (62.7)	3-1/2 (88.9)	2-1/32 (51.6)	2-3/4 (69.8)	2-5/16 (59)	—	2-17/32 (64.3)	3-9/16 (90.5)	2-1/32 (51.6)	2-13/16 (71.4)
Illuminated	Full Voltage	2-1/4 (57.2)	2-1/4 (57.2)	2-15/32 (62.7)	—	2-3/4 (69.8)	2-25/32 (70.6)	2-25/32 (70.6)	2-17/32 (64.3)	—	—	2-13/16 (71.4)
	Transformer	2-23/32 (69.1)	2-23/32 (69.1)	2-29/32 (73.8)	—	3-3/32 (78.6)	2-25/32 (70.6)	2-25/32 (70.6)	2-31/32 (75.4)	—	—	3-5/32 (80.1)
Non-Illuminated							Units Having Large Screw Terminals with Pressure Plates					
							2-45/64 (68.6)	—	2-59/64 (74.2)	3-15/16 (100)	—	3-13/64 (81.4)
Illuminated					Full Voltage		3-11/64 (80.6)	3-11/64 (80.6)	3-23/64 (85.3)	—	—	3-13/64 (81.4)
					Transformer		3-11/64 (80.6)	3-11/64 (80.6)	3-23/64 (85.3)	—	—	3-35/64 (90.1)

Approximate Mounting Dimensions

Caution: To avoid possible excessive heat, clusters of nine or more continuously illuminated units mounted in a small enclosure should be spaced at 1-1/2 in. (38.1 mm) minimum centers in one direction.

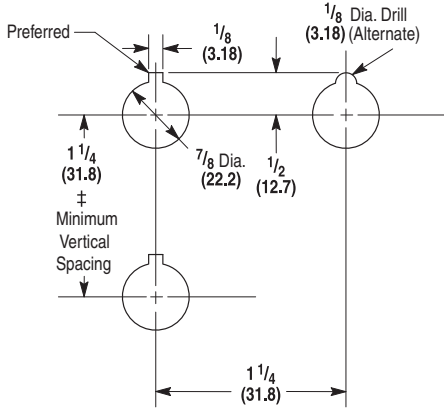

‡ Large screw terminal contact blocks require a minimum vertical spacing of 1-37/64 in. (40 mm); selector switches with wing lever knobs require 2-1/4 in. (57.1 mm) vertical and horizontal minimum spacing and large round legend plates require 1-1/2 in. (38.1 mm) minimum spacing.

Shipping Weights in Ounces (kg)							
Type of Unit		Weight	Type of Unit		Weight		
Push Buttons	Non-Illuminated	3-1/4 (0.09)	Selector Switches	Non-Illuminated	4 (0.11)		
	Illuminated	Full Voltage		3-1/2 (0.10)	Illuminated	Full Voltage	4 (0.11)
		Transformer		5 (0.14)		Transformer	5-1/2 (0.16)
Pilot Lights	Pilot Light	2-1/4 (0.06)	Push-Pull Units	Non-Illuminated		4-1/2 (0.13)	
	Push-to-Test	3 (0.09)		Illuminated	Full Voltage	4-1/2 (0.13)	
	Pilot Light	4-1/2 (0.13)			Transformer	5-1/2 (0.16)	
	Push-to-Test	5 (0.14)			Potentiometer Units		4 (0.11)
Cylinder Lock		6 (0.17)					

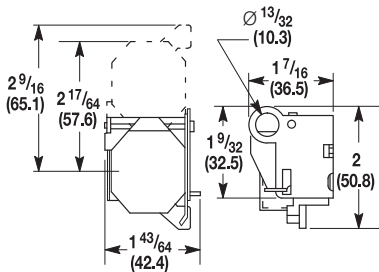

Padlocking Cover★
Cat. No. 800MR-N6

★ When using a padlocking cover and depending upon the types of adjacent units involved, the minimum vertical or horizontal spacing may have to be increased for operating clearance.

Dimensions in inches (millimeters). Dimensions are not intended to be used for manufacturing purposes.

Legend Plates

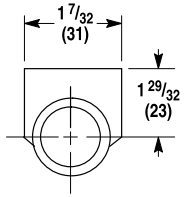

Standard Half Round Legend Plate★

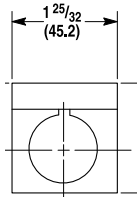

Standard Legend Plate§

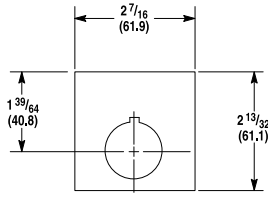

Large Size‡

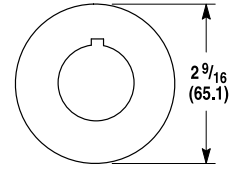

Round‡

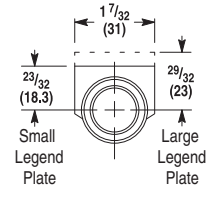

Small/Large Legend Plate

★ The Bulletin 800MR large half round legend plates are not recommended for use with the twist-release units because of the operator knob size. The legend plate is virtually unreadable. Push-pull units can be mounted in a 1-1/4 in. minimum horizontal spacing when no legend plate is used. Vertical spacing is 1-1/2 in. when the Bulletin 800MR large half round legend plate is used.

‡ These Bulletin 800MR legend plates consist of Bulletin 800T legend plates with Cat. No. 800MR-N50 adapter rings.

Important User Information

Read this document and the documents listed in the additional resources section about installation, configuration, and operation of this equipment before you install, configure, operate, or maintain this product. Users are required to familiarize themselves with installation and wiring instructions in addition to requirements of all applicable codes, laws, and standards.

Activities including installation, adjustments, putting into service, use, assembly, disassembly, and maintenance are required to be carried out by suitably trained personnel in accordance with applicable code of practice.

If this equipment is used in a manner not specified by the manufacturer, the protection provided by the equipment may be impaired.

In no event will Rockwell Automation, Inc. be responsible or liable for indirect or consequential damages resulting from the use or application of this equipment.

The examples and diagrams in this manual are included solely for illustrative purposes. Because of the many variables and requirements associated with any particular installation, Rockwell Automation, Inc. cannot assume responsibility or liability for actual use based on the examples and diagrams.

No patent liability is assumed by Rockwell Automation, Inc. with respect to use of information, circuits, equipment, or software described in this manual.

Reproduction of the contents of this manual, in whole or in part, without written permission of Rockwell Automation, Inc., is prohibited.

Documentation Feedback

Your comments will help us serve your documentation needs better. If you have any suggestions on how to improve this document, complete this form, publication [RA-DU002](#), available at <http://www.rockwellautomation.com/literature/>.

Allen-Bradley, Rockwell Software, Rockwell Automation, and LISTEN. THINK. SOLVE are trademarks of Rockwell Automation, Inc.
Trademarks not belonging to Rockwell Automation are property of their respective companies.

Rockwell Otomasyon Ticaret A.Ş., Kar Plaza İş Merkezi E Blok Kat:6 34752 İçerenköy, İstanbul, Tel: +90 (216) 5698400

www.rockwellautomation.com

Power, Control and Information Solutions Headquarters

Americas: Rockwell Automation, 1201 South Second Street, Milwaukee, WI 53204-2496 USA, Tel: (1) 414.382.2000, Fax: (1) 414.382.4444
Europe/Middle East/Africa: Rockwell Automation NV, Pegasus Park, De Kleetlaan 12a, 1831 Diegem, Belgium, Tel: (32) 2 663 0600, Fax: (32) 2 663 0640
Asia Pacific: Rockwell Automation, Level 14, Core F, Cyberport 3, 100 Cyberport Road, Hong Kong, Tel: (852) 2887 4788, Fax: (852) 2508 1846