

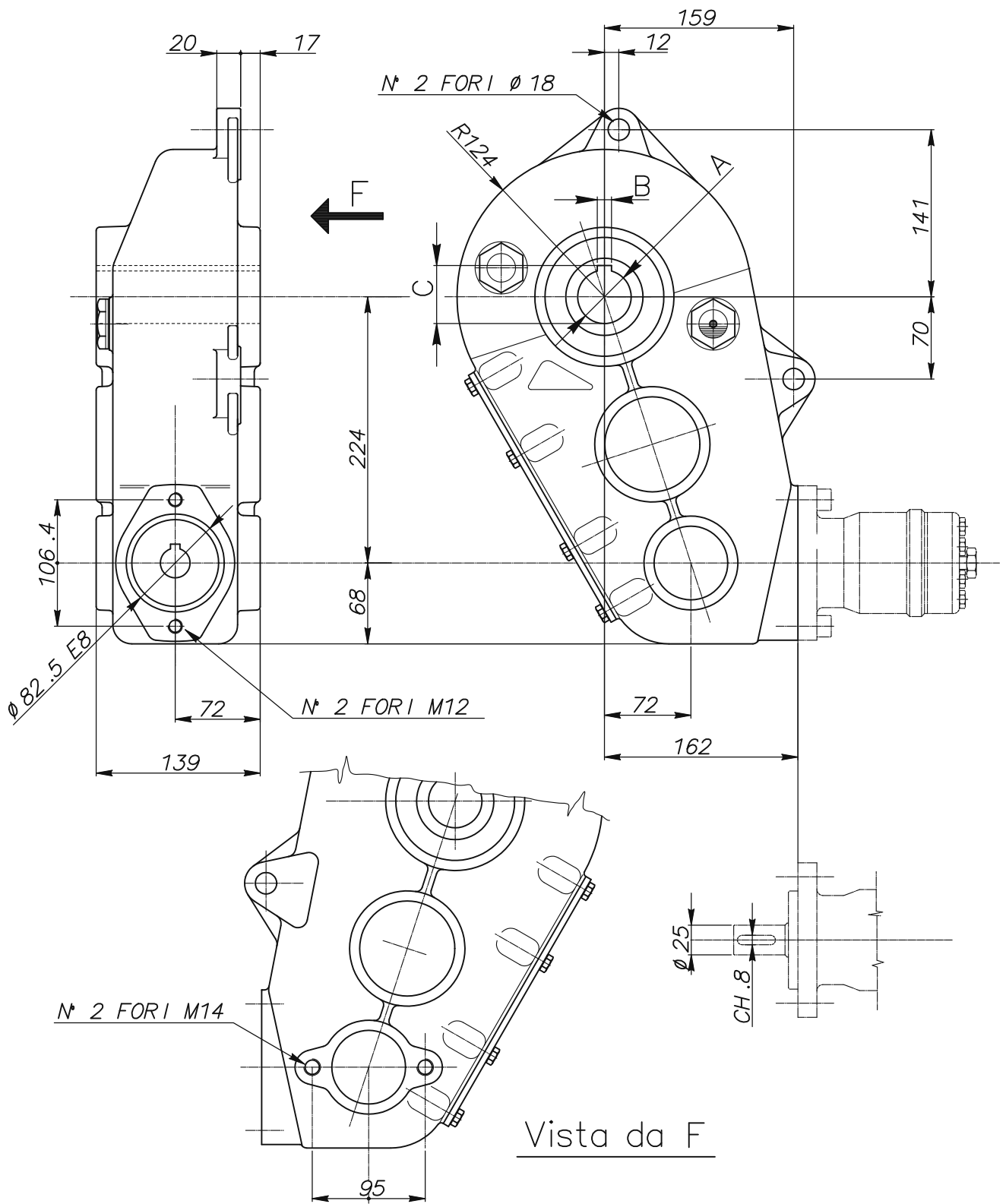

Riduttore RT 300



Marca	A	B	C	Peso kg.	Rapporto	Mt.in uscita N m	Olio		Temperatura d'impiego:
	E8	E8					Tipo	Quantita Kg	
8900	35	10	38,8	34	29,5:1	3000	SAE 90 EP	3,8	-20° C +80° C
8640	40	12	43,8						
8670	45	12	48,8						