



PRODUCT DATA SHEET

REV. 14

ML







INDICE / INDEX:

Dati generali / <i>General features</i>	5
Dimensioni d'ingombro e schema idraulico / <i>Overall dimension and hydraulic scheme</i>	6
Curve caratteristiche / <i>Characteristic curves</i>	7
Opzioni generali / <i>General options</i>	14
Tipo di entrata / <i>Inlet type</i>	15
Filettature bocche P – P1 / <i>Thread port P – P1</i>	16
Opzioni su bocca P – P1 / <i>Options on port P – P1</i>	16
Valvola di massima pressione / <i>Main relief valve</i>	17
Filettature bocche A - B / <i>Thread port A - B</i>	18
Azionamenti / <i>Actuators</i>	19
Spole / <i>Spools</i>	26
Posizionatori / <i>Spool controls</i>	31
Compatibilità spole-posizionatore / <i>Spool controls compatibility chart</i>	38
Compatibilità azionamento-spole / <i>Actuator compatibility chart</i>	39
Valvola limitatrice di pressione per bocche A-B / <i>Relief valve for port A-B</i>	40
Opzioni leva / <i>Lever options</i>	41
Opzioni lato posizionatore / <i>Options spool control side</i>	42
Filettature bocche T – T1 / <i>Thread port T – T1</i>	44
Filettature bocca T4 / <i>Thread port T4</i>	44
Opzioni su bocca T – T1 – T4 / <i>Options on port T – T1 – T4</i>	44
Opzioni a scarico / <i>Discharge options</i>	45
Opzioni speciali / <i>Special options</i>	46
Istruzioni per l'ordinazione / <i>Ordering instructions</i>	50
Lista ricambi / <i>Spare part list</i>	53





Dati generali / General features

Numero di sezioni – <i>Number of sections</i>	Da 1 a 7	<i>From 1 to 7</i>
Tipo circuito – <i>Circuit type</i>	Parallelo	<i>Parallel</i>
Diametro spola – <i>Spool diameter</i>	15 mm	<i>0,59 in</i>
Predisposizione Carry-over – <i>Carry-over prearrangement</i>	Standard	<i>Standard</i>

Caratteristiche di funzionamento idrauliche / Hydraulic working features

Le seguenti caratteristiche sono influenzate dalle condizioni dei test. I valori sono ottenuti con un olio con una viscosità di 21 cSt, ad una temperatura di 50°C, con cursori a doppio effetto e sono valide per le filettature standard.

The following characteristics are influenced by testing conditions. Values are obtained with oil at viscosity of 21 cSt, temperature of 50°C, double acting spool and are valid only for standard threads.

Nota: per differenti condizioni di utilizzo contattare il servizio clienti.

Note: For different conditions of use please contact customer service.

Portata nominale – <i>Nominal flow rate</i>	35 l/min.	<i>9,2 US gpm</i>
Pressione nominale – <i>Nominal pressure</i>	250 bar	<i>3625 psi</i>
Contropressione massima a scarico – <i>Maximum tank pressure</i>	50 bar	<i>725 psi</i>
Massima trafila interna – <i>Maximum internal leakage (A or B => P and T) p = 100 bar</i>	8 cc/min ± 20	

Fluido idraulico / Hydraulic fluid

Si raccomanda di utilizzare fluidi idraulici definiti dalla norma ISO 6743-4	<i>It is recommended to use hydraulic fluid as specified on norm ISO 6743-4.</i>
Per fluidi di lavoro differenti contatta il nostro ufficio vendite.	<i>For different fluid, please contact our sales department.</i>

Campo di lavoro del fluido / Fluid working range

Temperatura statica di lavoro – <i>Operating static temperature</i>	<i>-20°C +85°C NBR seals (max peak +100°C) -20°C + 130°C HNBR seals</i>
Viscosità olio d'esercizio – <i>Operating oil viscosity</i>	<i>Da 15 cSt a 90 cSt / From 15 cSt to 90 cSt</i>



Dimensioni d'ingombro e schema idraulico / Overall dimension and hydraulic scheme

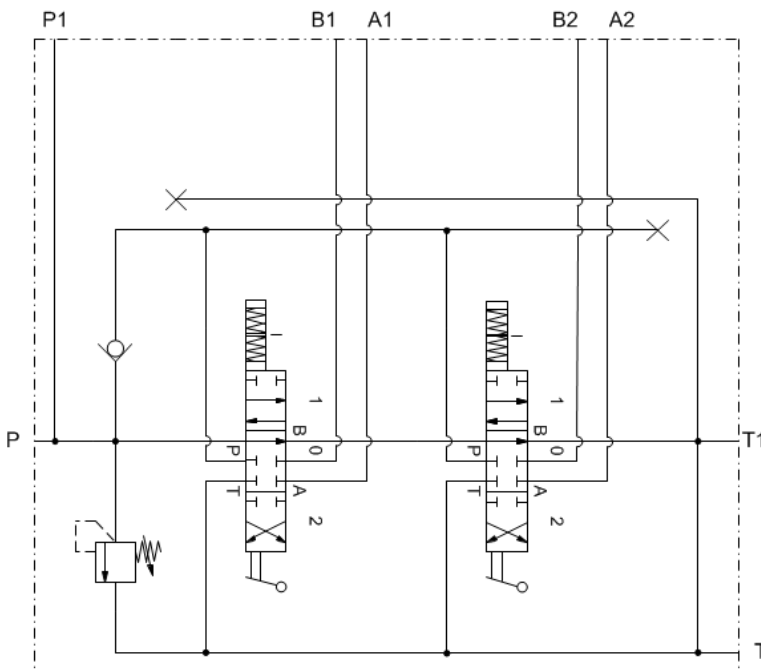
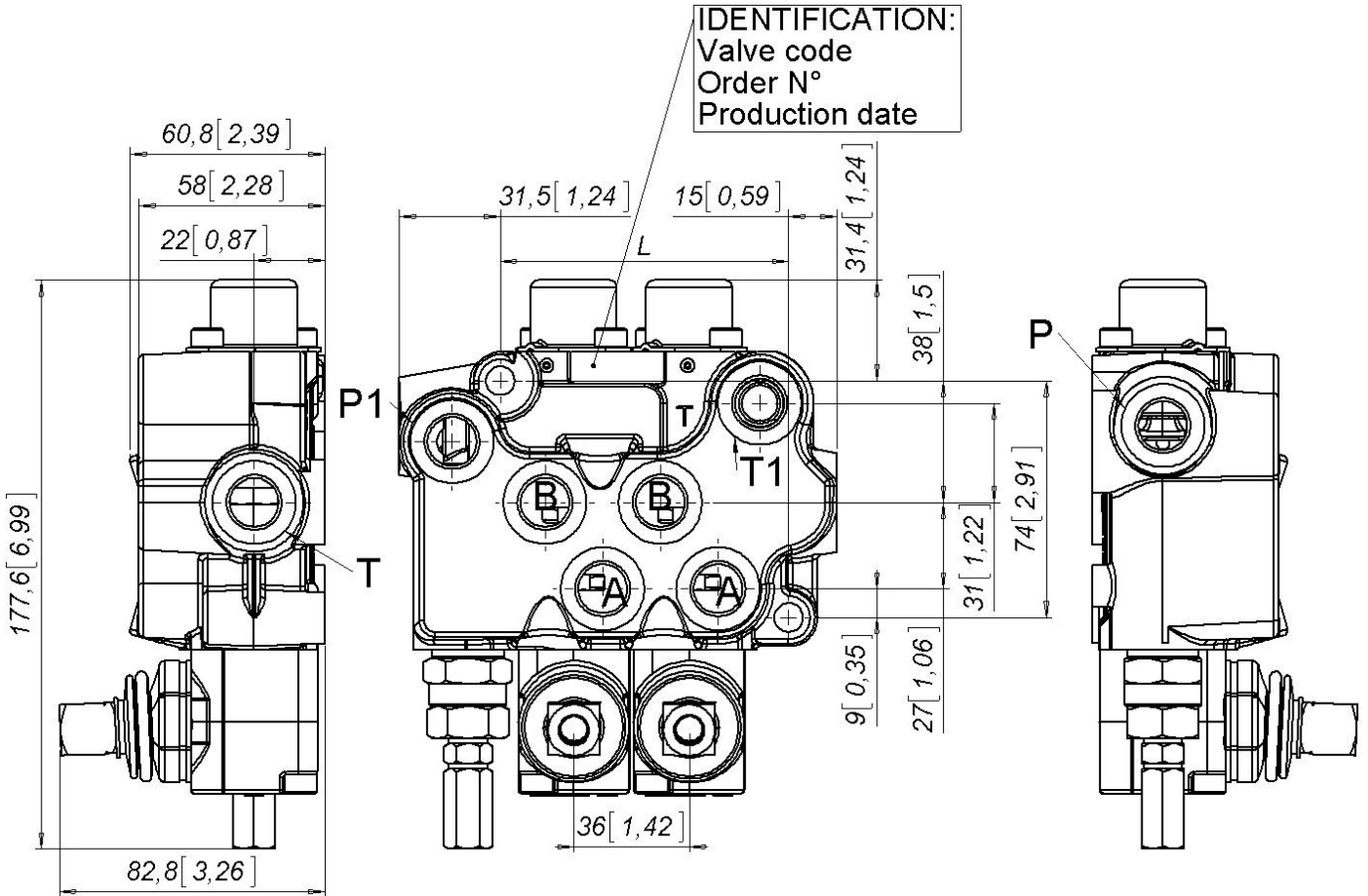

Circuito standard – Standard circuit
(ML2 010A 010A)

N° di sezioni N° of section	L [mm]	P [Kg]	L [inch]	P [lb]
ML1	54	2,9	2,12	6,4
ML2	90	4,2	3,54	9,2
ML3	126	5,3	4,96	11,7
ML4	162	6,6	6,37	14,5
ML5	198	7,8	7,8	17,2
ML6	234	9,0	9,21	19,9
ML7	270	10,2	10,35	22,6



Curve caratteristiche / Characteristic curves

Tutte le curve sono state ottenute con olio ad una temperatura di 50°C e una viscosità di 21cSt

All curves are obtained with oil at 21 cSt of viscosity (50°C)

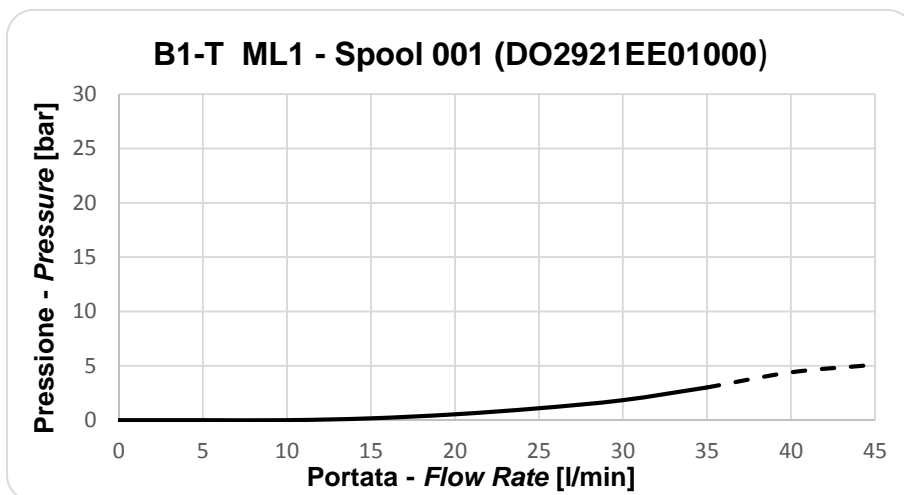
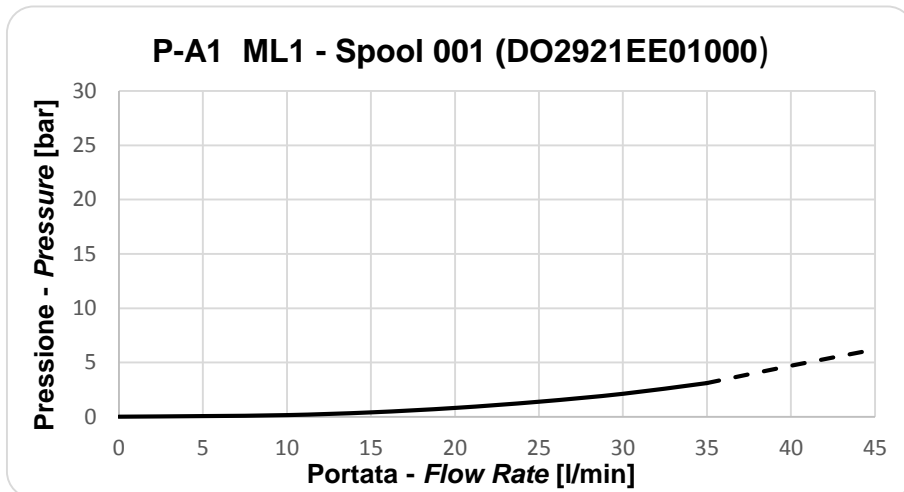
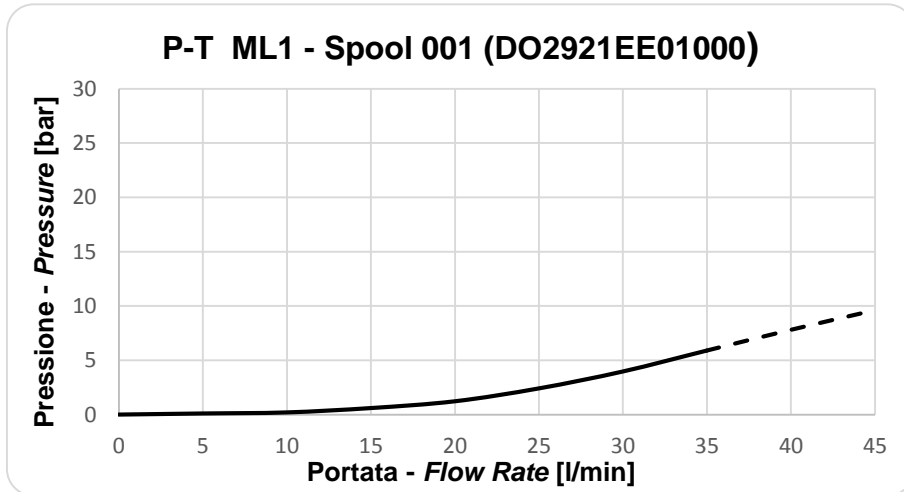



P-T ML2 - Spool 001 (DO2921EE01000)

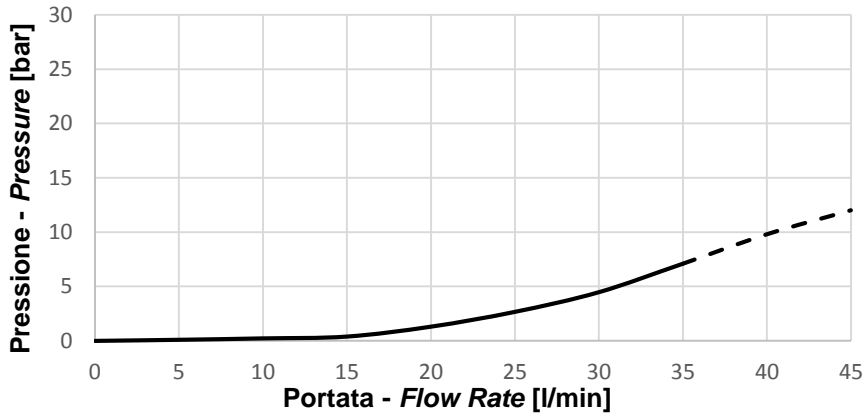

P-A2 ML2 - Spool 001 (DO2921EE01000)

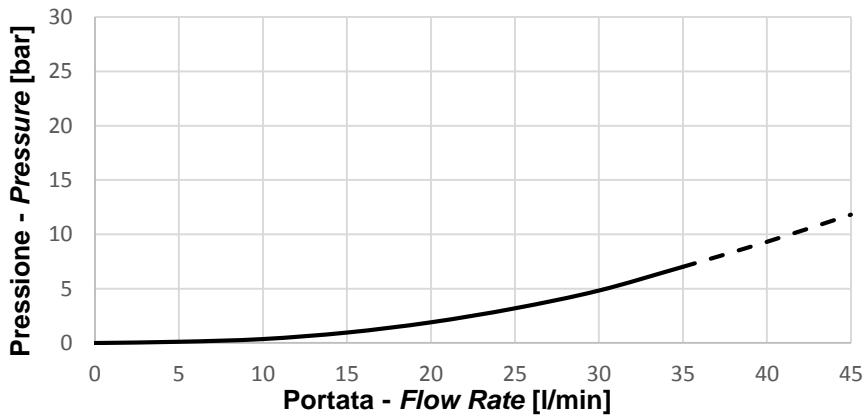

B1-T ML2 - Spool 001 (DO2921EE01000)

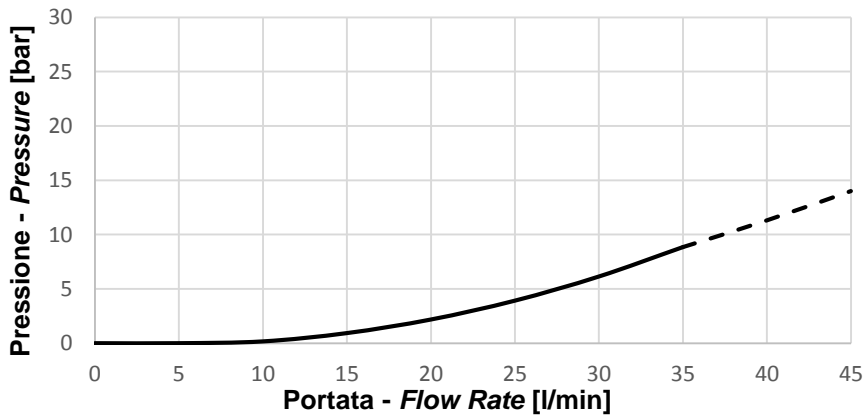



P-T ML3 - Spool 001 (DO2921EE01000)

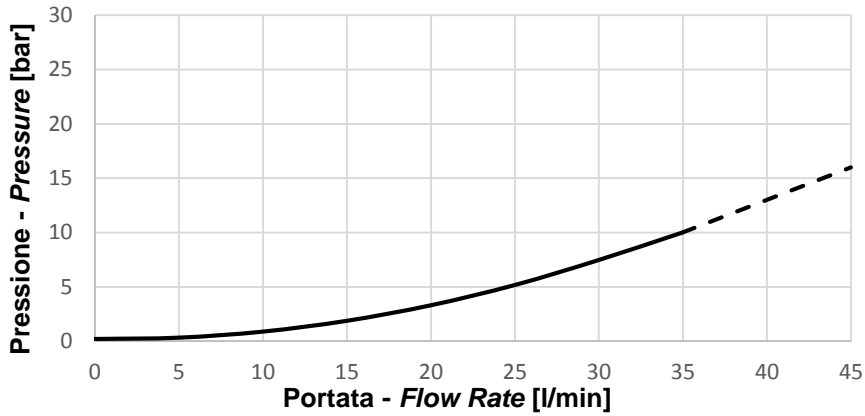

P-A3 ML3 - Spool 001 (DO2921EE01000)

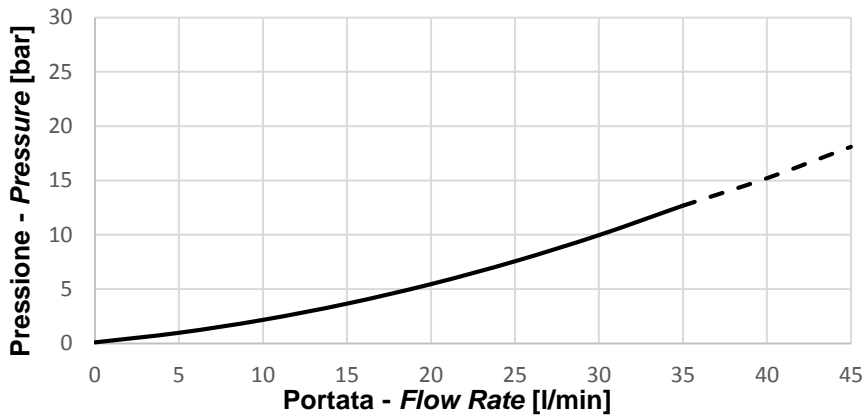

B1-T ML3 - Spool 001 (DO2921EE01000)

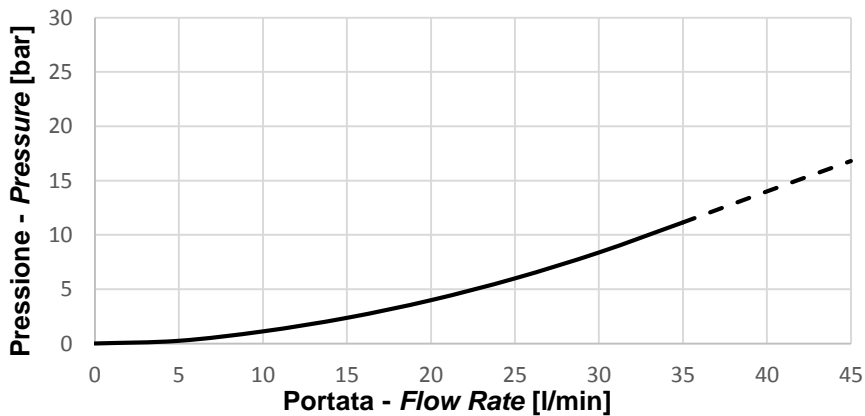



P-T ML4 - Spool 001 (DO2921EE01000)

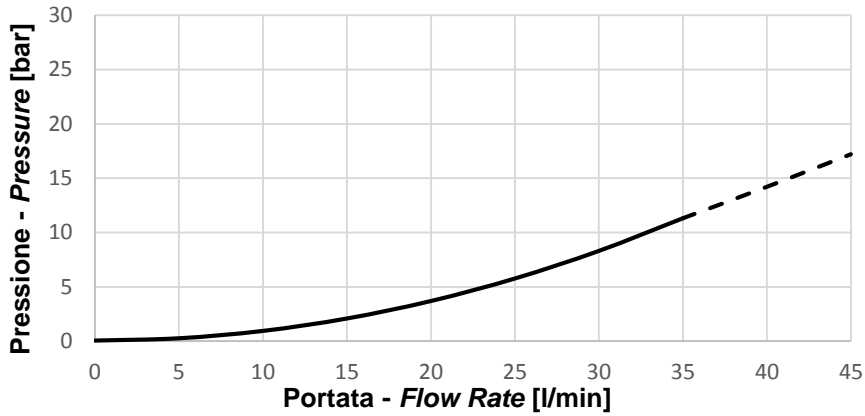

P-A4 ML4 - Spool 001 (DO2921EE01000)

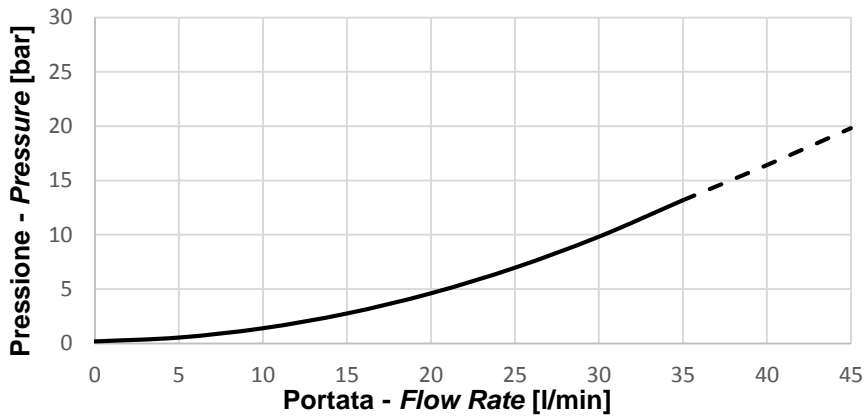

B1-T ML4 - Spool 001 (DO2921EE01000)

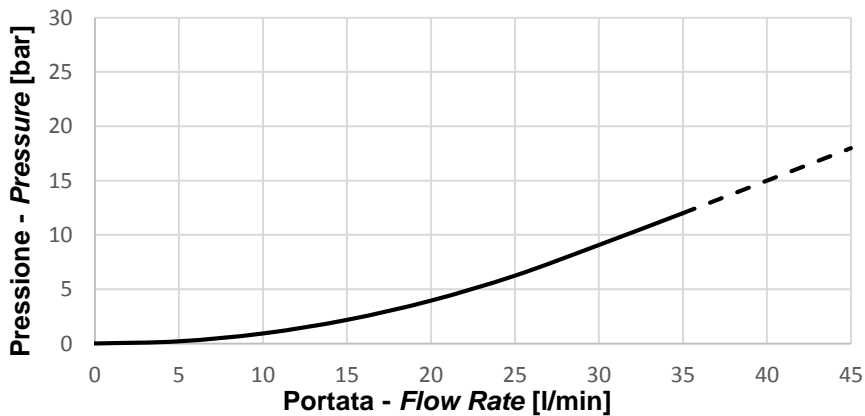



P-T ML5 - Spool 001 (DO2921EE01000)

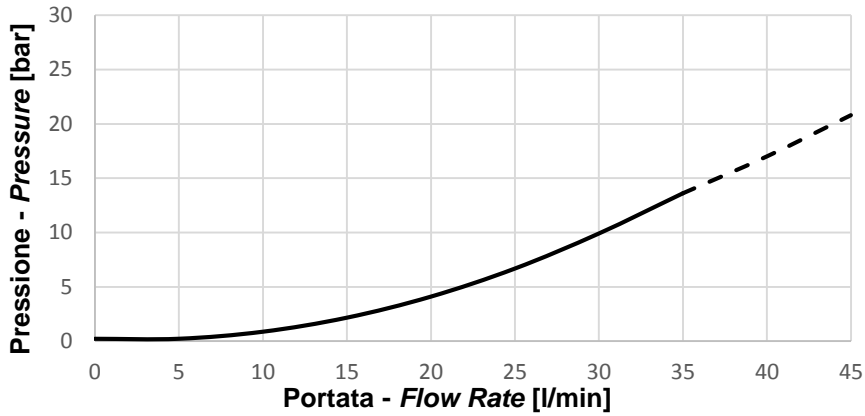

P-A5 ML5 - Spool 001 (DO2921EE01000)

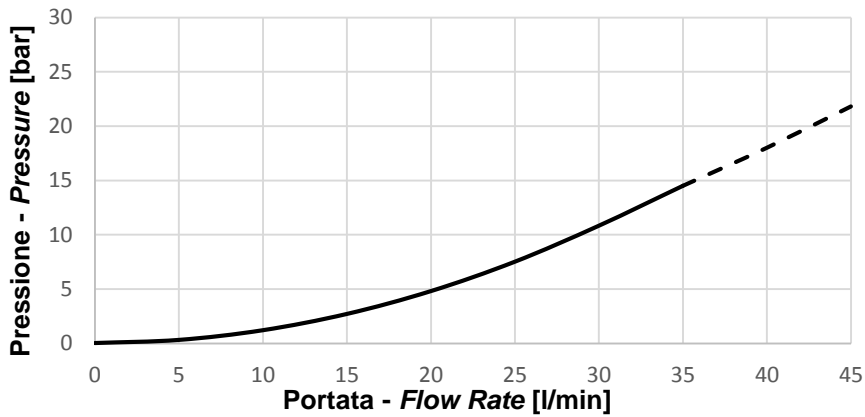

B1-T ML5 - Spool 001 (DO2921EE01000)

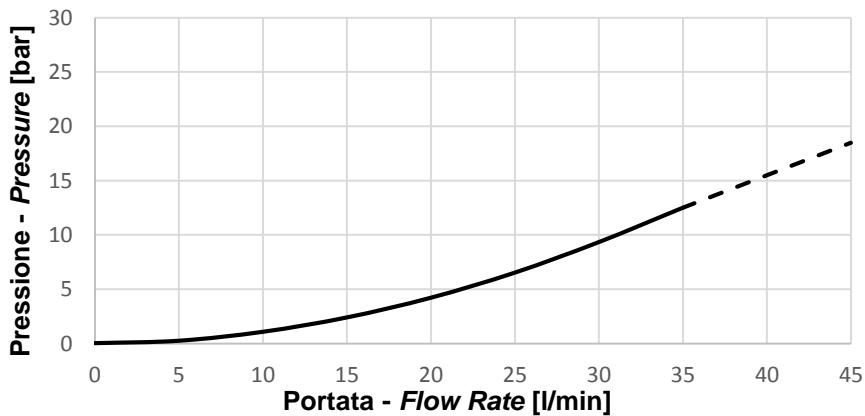



P-T ML6 - Spool 001 (DO2921EE01000)

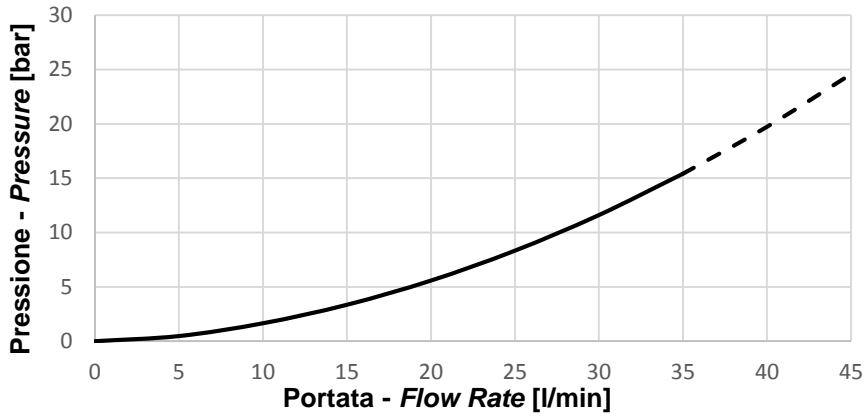

P-A6 ML6 - Spool 001 (DO2921EE01000)

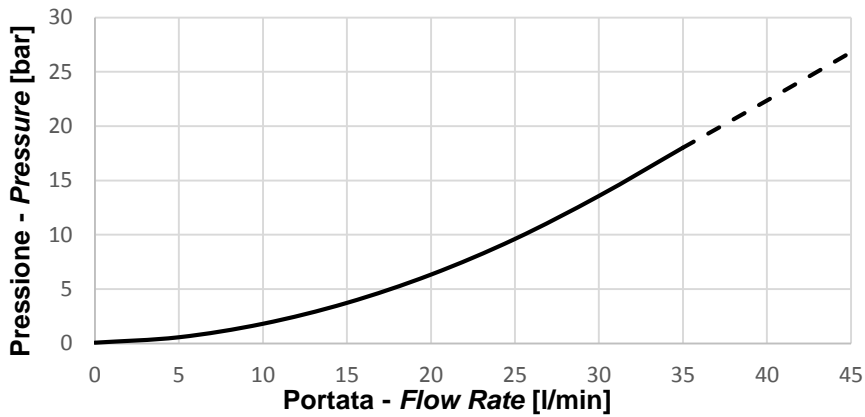

B1-T ML6 - Spool 001 (DO2921EE01000)

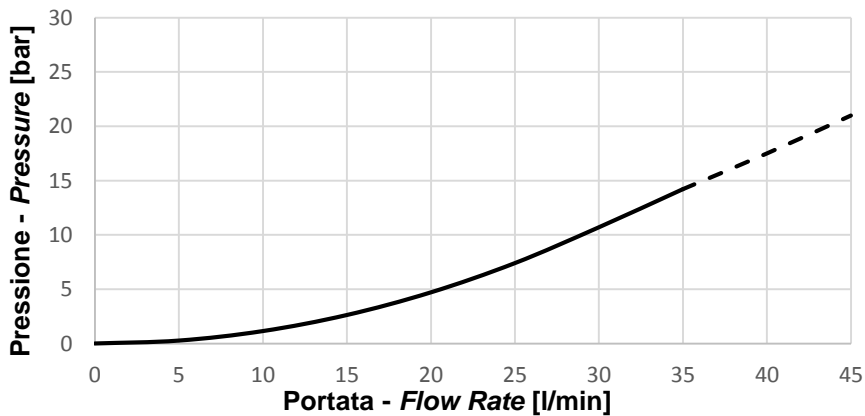



P-T ML7 - Spool 001 (DO2921EE01000)

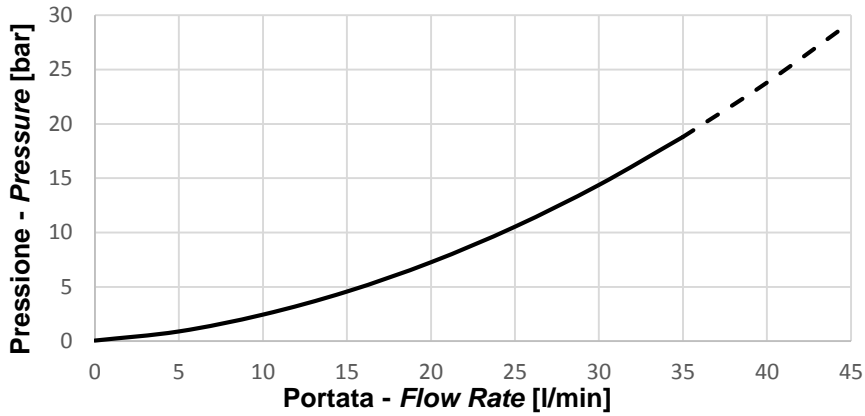

P-A7 ML7 - Spool 001 (DO2921EE01000)

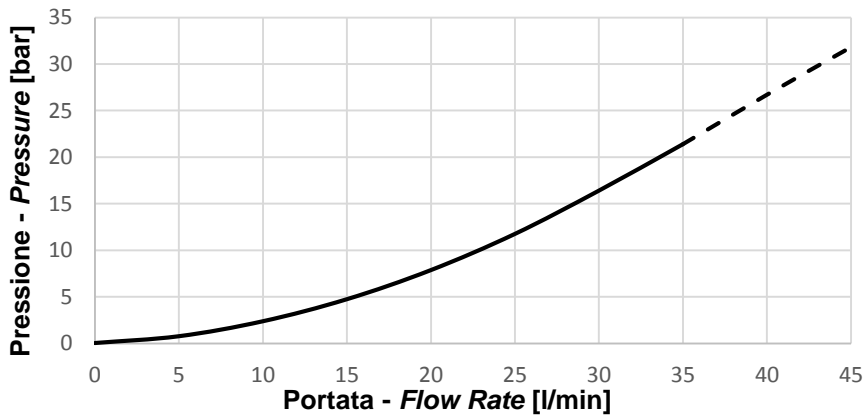

B1-T ML7 - Spool 001 (DO2921EE01000)

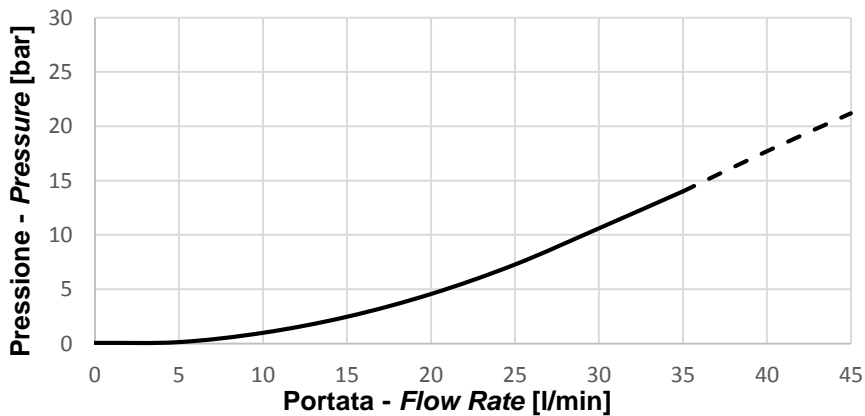



Opzioni generali / General options

M	Micro centralizzato <i>Centralized microswitch</i>	
O	Micro centralizzato verniciatura nera <i>Centralized microswitch black paint</i>	
Per micro centralizzato, usare posizionatore / For centralize micro, use spool control: DO580550A39		

	ML1	DO5603601-- + DO56102
	ML2	DO5603602-- + DO56102
	ML3	DO5603603-- + DO56102
	ML4	DO5603604-- + DO56102
	ML5	DO5603605-- + DO56102
	ML6	DO5603606-- + DO56102
	ML7	DO5603607-- + DO56102

Caratteristiche Micro / Micro characteristics	
Portata dei contatti / <i>Contact rating</i>	16(5)A at 250V A.C 50Hz. – 3A at 30V D.C. L/R=5ms
Temperatura di funzionamento / <i>Operating temperature</i>	-20° to 85° C
Vita meccanica attesa / <i>Expected mechanical life</i>	10 million operations at 1Hz
Isolamento / <i>Initial insulation</i>	Up to 100 MΩ



Tipo di entrata / Inlet type

La bocca A è definita dalla posizione della leva. Quando il distributore ha entrata destra, le bocche A – B sono invertite

Port A is defined by the lever side. When valve is right inlet, the position of the letter associated to port is inverted

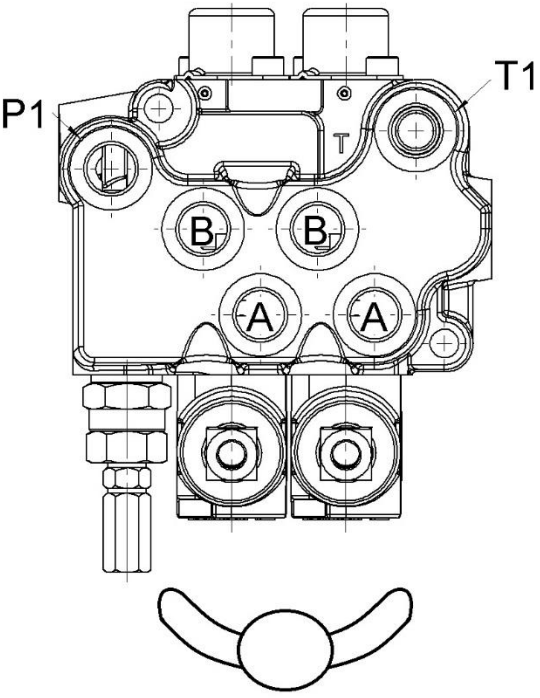
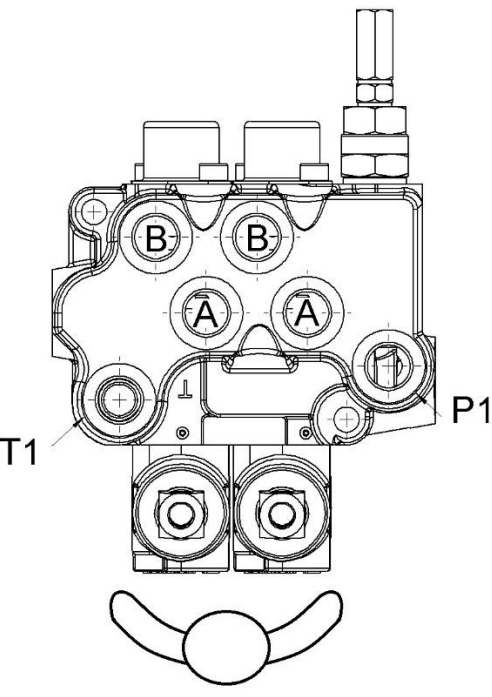
<p>Entrata sinistra (Standard)</p>	<p><i>Left inlet (Standard)</i></p>	
<p>Entrata destra</p>	<p><i>Right inlet</i></p>	



Sezione / Section

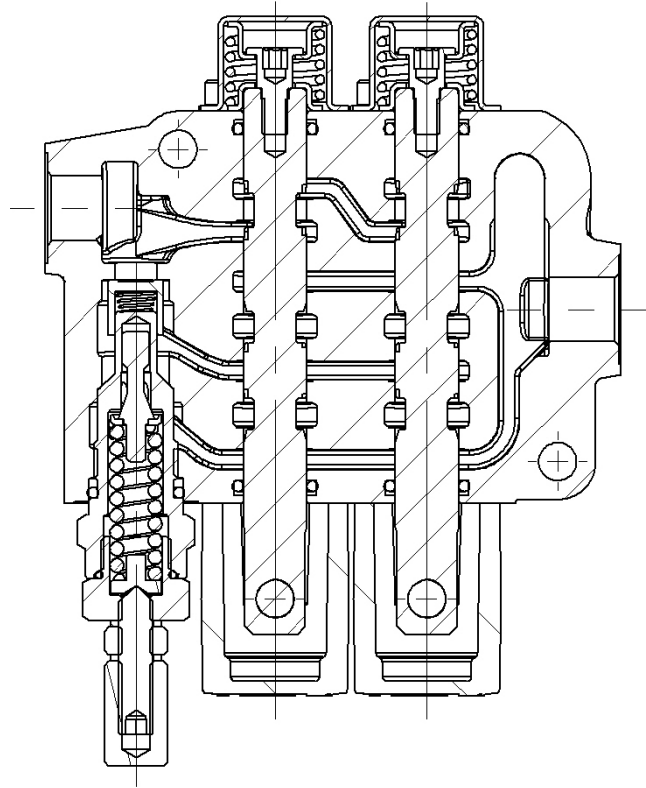

Filettature bocche P – P1 / Thread port P – P1

Codice filettatura <i>Thread code</i>	Tipo <i>Type</i>	Serraggio [Nm] <i>Torque [Nm]</i>
A	3/8" GAS ISO 1179	35
B	1/2" GAS ISO 1179	70
T	M16x1,5 ISO 9974	24
C	M18x1,5 ISO 9974	40
I	M16x1,5 ISO 6149	24
W	M18x1,5 ISO 6149	40
P	9/16-18 SAE ISO 11926	21
E	3/4-16 SAE ISO 11926	50

Opzioni su bocca P – P1 / Options on port P – P1

A	P aperto – P1 aperto (Standard)	<i>P open – P1 open (Standard)</i>
B	P aperto – P1 tappato	<i>P open – P1 plugged</i>
C	P tappato – P1 aperto	<i>P plugged – P1 open</i>



Valvola di massima pressione / Main relief valve

L'impostazione standard si riferisce a 5 l/min \pm 10%
della portata, le pressioni sono fissate a multipli di 10 bar

Standard setting is referred to 5 l/min \pm 10% of flow rate,
setting pressures are multiples of 10 bar

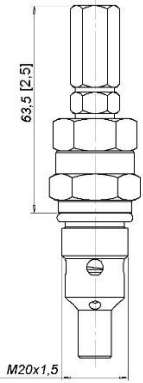
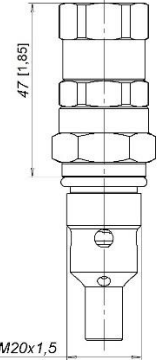
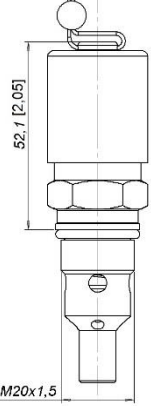
Tipo / Type		Codice di ordinazione Ordering code		Pressione di esercizio Operating pressure
		Codice tipo Type code	Codice pressione Pressure code	
DOWPD02M20--- G – grano G - grain		02	X (80)	30–80 bar (standard setting 80 bar)
			Y (130)	90–130 bar (standard setting 130 bar)
			Z (180)	140–180 bar (standard setting 180 bar)
			K (210)	190–210 bar (standard setting 210 bar)
			H (250)	220–250 bar (standard setting 250 bar)
DOWPD00M20--- C – cappuccio C – cap		00	X (80)	30–80 bar (standard setting 80 bar)
			Y (130)	90–130 bar (standard setting 130 bar)
			Z (180)	140–180 bar (standard setting 180 bar)
			K (210)	190–210 bar (standard setting 210 bar)
			H (250)	220–250 bar (standard setting 250 bar)
DOWPD203-4--- P – piombata P – lead sealed		20	X (80)	30–80 bar (standard setting 80 bar)
			Y (130)	90–130 bar (standard setting 130 bar)
			Z (180)	140–180 bar (standard setting 180 bar)
			K (210)	190–210 bar (standard setting 210 bar)
			H (250)	220–250 bar (standard setting 250 bar)



DO58802

Tappo sostitutivo
*Replacement
screw plug*

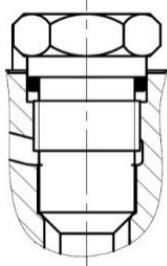

Caratteristiche valvola di massima pressione
Main relief valve characteristics

Portata nominale <i>Nominal flow rate</i>	50 l/min
Cavità <i>Cavity</i>	LDIME009
Coppia di serraggio <i>Tightening torque</i>	65±5 Nm

Curve caratteristiche
Characteristic curves

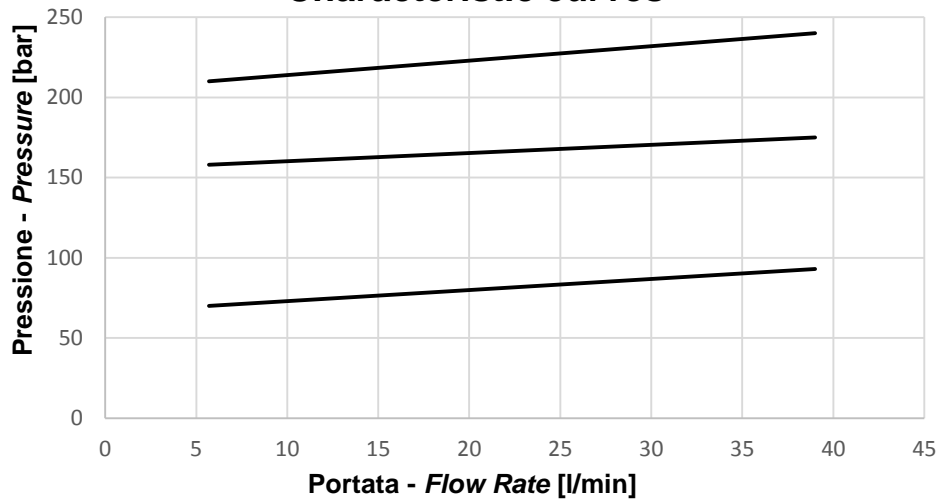

Parametri di prova / *Oil Testing Parameters: 50 °C – 21 cSt*

Filettature bocche A - B / Thread port A - B

Codice filettatura <i>Thread code</i>	Tipo <i>Type</i>	Serraggio [Nm] <i>Torque [Nm]</i>
A	3/8" GAS ISO 1179	35
T	M16x1,5 ISO 9974	24
C	M18x1,5 ISO 9974	40
I	M16x1,5 ISO 6149	24
W	M18x1,5 ISO 6149	40
E	3/4-16 SAE ISO 11926	50



Azionamenti / Actuators

Codice con casella grigia è fuori standard / Code with grey box is not a standard solution

<p>L</p>	<p>DO57010817 Standard kit portaleva <i>Standard kit lever</i></p>	
<p>L</p>	<p>DO57013604 Kit portaleva senza protezione in gomma <i>Lever kit without rubber boot</i></p>	
<p>A</p>	<p>Senza portaleva appendice standard <i>Without lever holder standard appendix</i></p>	
<p>B</p>	<p>Senza portaleva senza appendice <i>Without lever holder without appendix</i></p>	

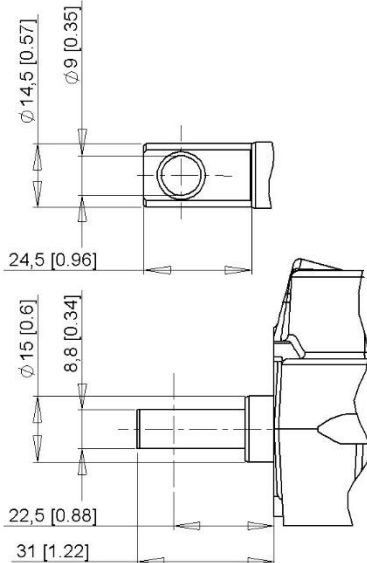
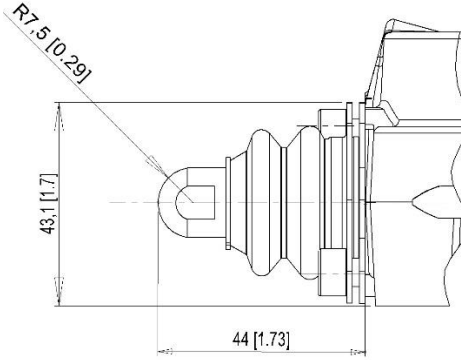
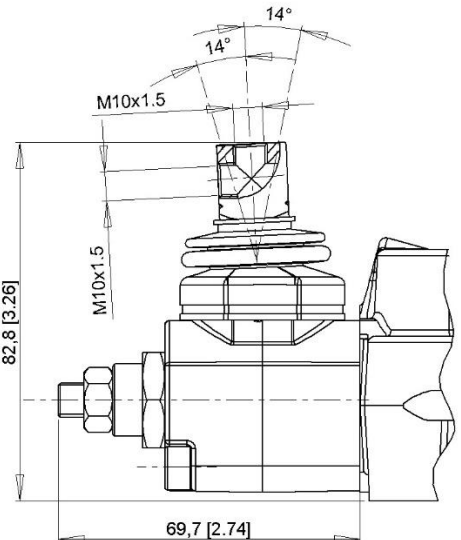

<p>C</p>	<p>Senza portaleva appendice piatta <i>Without lever holder flat appendix</i></p>	
<p>9</p>	<p>Azionamento a sfera integrate <i>Actuator with integrated ball</i></p>	
<p>Z</p>	<p>DO57012303 Manuale con limitatore di corsa <i>Manual with stroke limiter</i></p>	

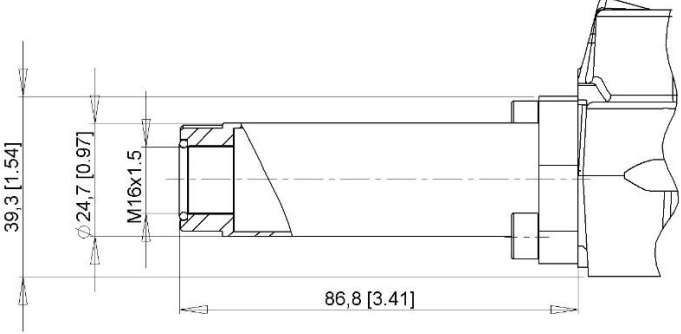
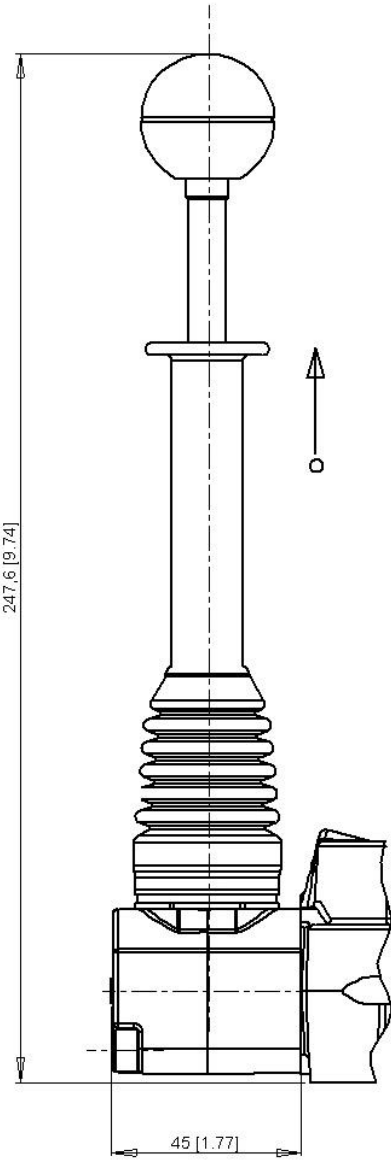

<p>T</p>	<p>DO74508212056 Predisposizione cavo lato azionamento <i>Cable setting on actuator side</i></p>	
<p>V</p>	<p>DO54036002 Intenzionale verticale <i>Intentional vertical</i></p>	



<p>O</p>	<p>DO54036006 Intenzionale orizzontale <i>Intentional horizontal</i></p>	
-----------------	---	--

<p>M</p>	<p>DO55513615 Manipolatore <i>Joystick</i></p>	
		<p>FLOATING FLOATING</p> <p>3 ↑ (*)</p> <p>(*) L'INCLINAZIONE DELLA LEVA DIPENDE DAL CIRCUITO THE ANGLE OF THE LEVER DEPENDS FROM THE CIRCUIT</p> <p>DISPONIBILE ANCHE IN ALTRE CONFIGURAZIONI ALSO AVAILABLE IN OTHER CONFIGURATIONS</p>



G

DO55513642

Manipolatore con blocca spole
Joystick with spools lock

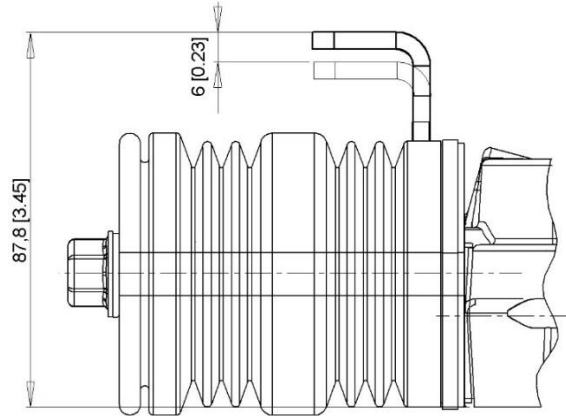

Per altri dettagli, vedere l'opzione M
For other details, see M option

K

DO5XH15536010

Comando idraulico
Hydraulic control

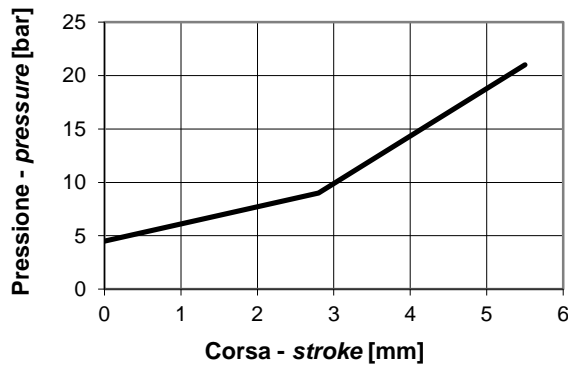
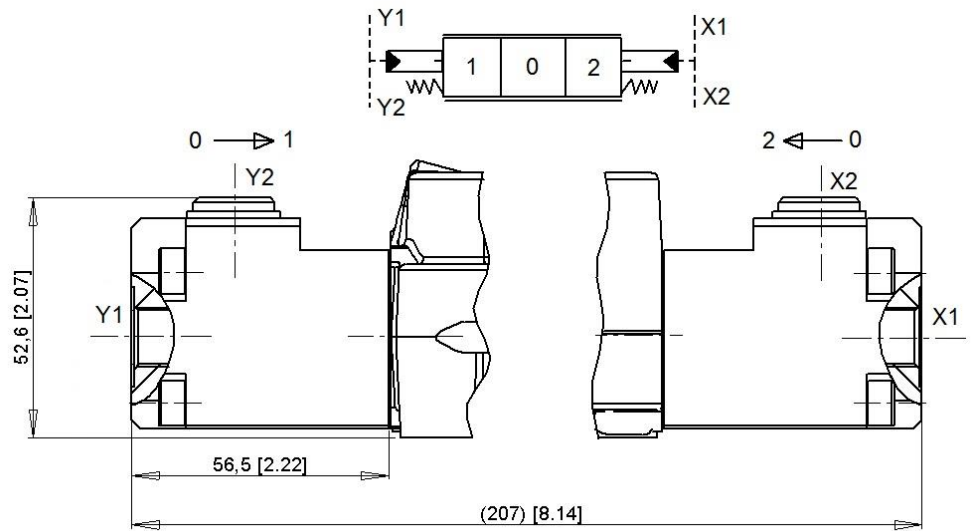

Filettatura bocche X – Y <i>Thread ports X – Y</i>
1/4" GAS
M14x1,5
9/16 – 18 SAE



P

DO5XG55362002
Comando pneumatico
Pneumatic control

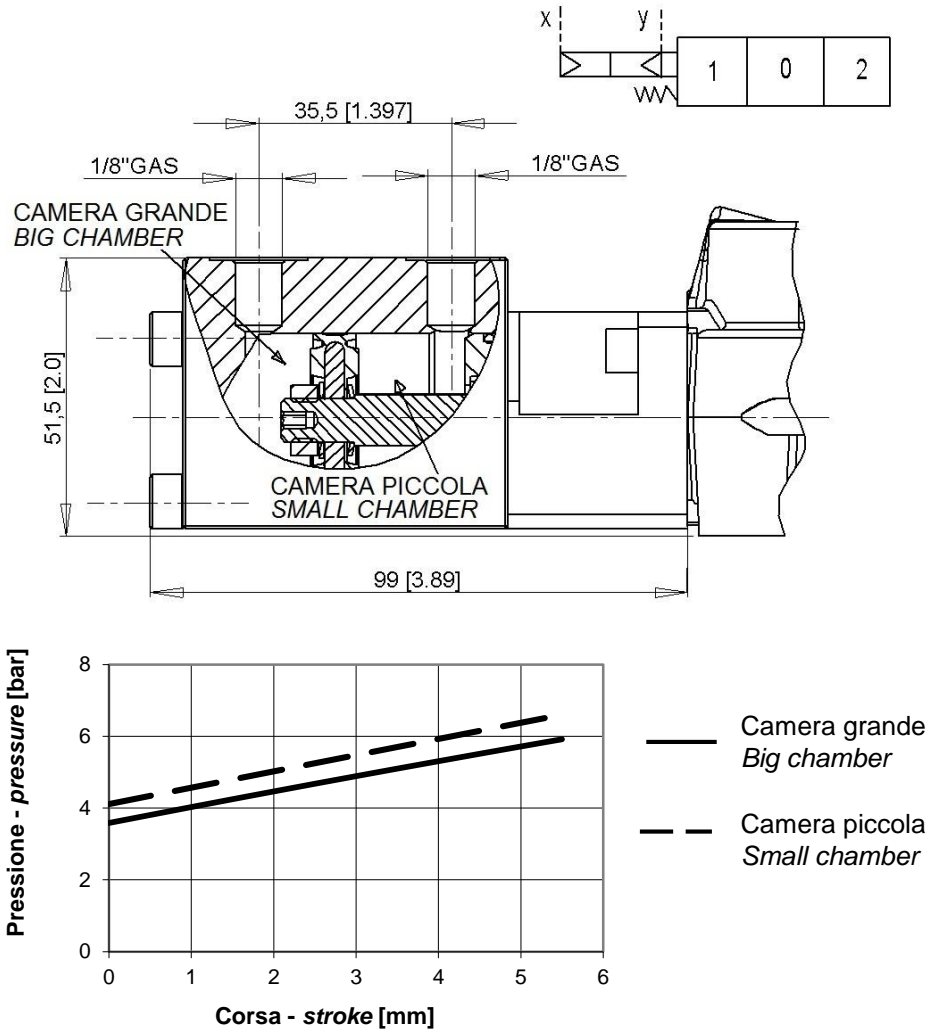



DO57010223

Portaleva ruotato di 90°
lato VMP

*90° rotated lever to VMP
side*

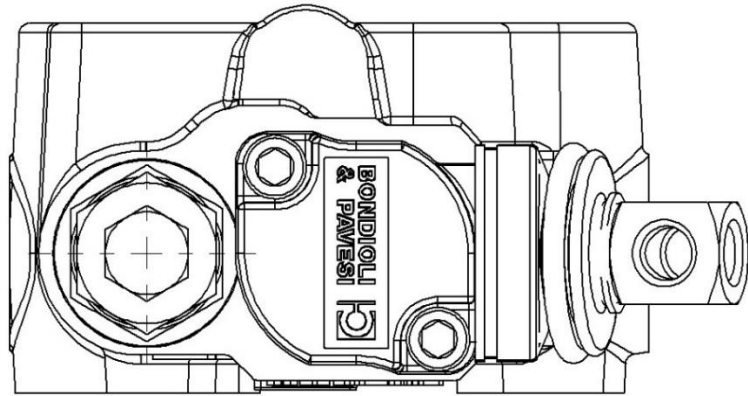

DO57010835

Portaleva ruotato di 90°
lato opposto VMP

*90° rotated lever to
opposite VMP side*

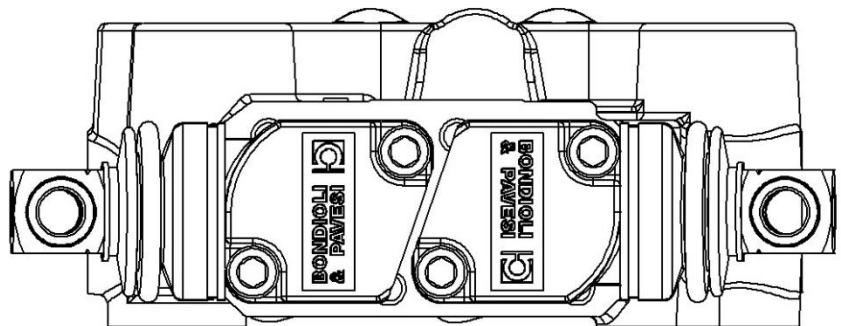



Spole / Spools

01	DO2921EE01000		<p>Entrata sinistra / <i>Left inlet</i>, Corsa / <i>Stroke</i> 5,5_5,5</p>
01	DO2921EE01033		<p>Entrata destra / <i>Right inlet</i>, Corsa / <i>Stroke</i> 5,5_5,5</p>
03	DO2921EE03000		<p>Entrata sinistra / <i>Left inlet</i>, Corsa / <i>Stroke</i> 5,5_5,5</p>
03	DO2921EE03009		<p>Entrata destra / <i>Right inlet</i>, Corsa / <i>Stroke</i> 5,5_5,5</p>
04	DO2921EE04015		<p>Entrata sinistra / <i>Left inlet</i>, Corsa / <i>Stroke</i> 5,5_5,5 Ghisa dedicata / <i>Dedicated cast iron</i></p>
04	DO2921EE04016		<p>Entrata destra / <i>Right inlet</i>, Corsa / <i>Stroke</i> 5,5_5,5 Ghisa dedicata / <i>Dedicated cast iron</i></p>

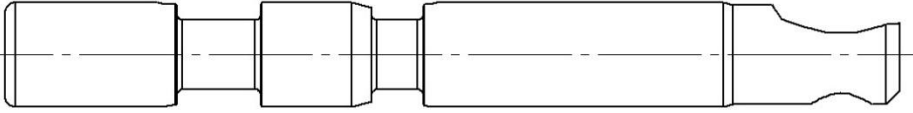
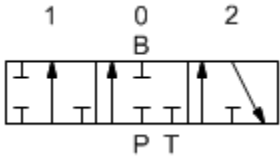
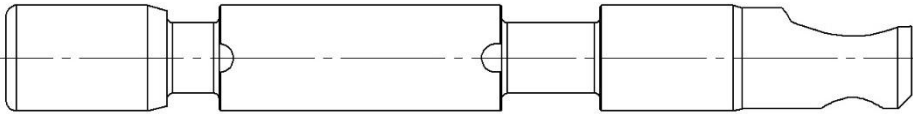
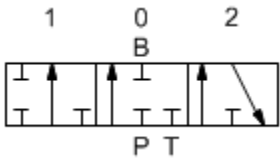
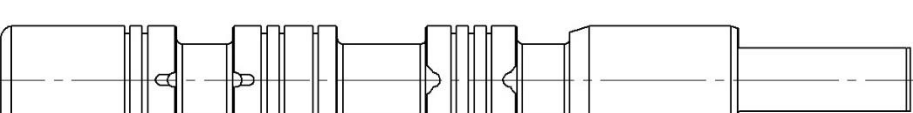
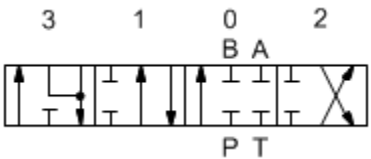

05	DO2921EE05008	 <p>Entrata sinistra / <i>Left inlet</i>; Corsa / <i>Stroke</i> 5,5_5,5 Ghisa dedicata / <i>Dedicated cast iron</i></p>
05	DO2921EE05010	 <p>Entrata destra / <i>Right inlet</i>; Corsa / <i>Stroke</i> 5,5_5,5 Ghisa dedicata / <i>Dedicated cast iron</i></p>
07	DO2922EE07000	 <p>Entrata sinistra / <i>Left inlet</i>; Corsa / <i>Stroke</i> 5,5_5_5 Ghisa dedicata / <i>Dedicated cast iron</i></p>
08	DO2928EE08000	 <p>Left inlet, with flat extension; stroke 5,5_5,5</p>
10	DO2928EE10000	 <p>Left inlet, with extension; stroke 5,5_5,5</p>
70	DO2922EE70000	 <p>Entrata destra / <i>Right inlet</i>; Corsa / <i>Stroke</i> 5_5_5,5 Ghisa dedicata / <i>Dedicated cast iron</i></p>

Codice con casella grigia è fuori standard / Code with grey box is not a standard solution

Circuit	Code	Inlet type	Type of extension	Flow rate
01	DO2921EE01000	Left	With extension	Standard
01	DO2921EE01033	Right	With extension	Standard
01	DO2922EE01000	Left	With extension	20-45 l/min.
01	DO2922EE01002	Right	With extension	20-45 l/min.
01	DO2922EE01003	Left	With extension	8-20 l/min.
01	DO2922EE01004	Right	With extension	8-20 l/min.
01	DO2922EE01008	Left	Without extension	20-45 l/min.
01	DO2922EE01009	Right	Without extension	20-45 l/min.
01	DO2928EE01001	Left	With flat extension - also for joystick	20-45 l/min.
01	DO2928EE01003	Right	With flat extension - also for joystick	20-45 l/min.
01	DO2928EE01010	Left	With flat extension - also for joystick	8-20 l/min.
03	DO2921EE03000	Left	With extension	Standard
03	DO2921EE03009	Right	With extension	Standard
03	DO2922EE03000	Left	With extension	20-45 l/min.
03	DO2922EE03004	Right	With extension	20-45 l/min.
03	DO2922EE03003	Left	With extension	8-20 l/min.
03	DO2922EE03005	Right	With extension	8-20 l/min.
03	DO2922EE03007	Left	Without extension	20-45 l/min.
03	DO2922EE03008	Right	Without extension	20-45 l/min.
03	DO2928EE03001	Left	With flat extension - also for joystick	20-45 l/min.
03	DO2928EE03002	Right	With flat extension - also for joystick	20-45 l/min.
03	DO2928EE03009	Left	With flat extension - also for joystick	8-20 l/min.
04	DO2921EE04015	Left	With extension	Standard
04	DO2921EE04016	Right	With extension	Standard
04	DO2922EE04000	Left	With extension	20-45 l/min.
04	DO2922EE04002	Right	With extension	20-45 l/min.
04	DO2922EE04001	Left	With extension	8-20 l/min.
04	DO2922EE04003	Right	With extension	8-20 l/min.
04	DO2922EE04007	Left	Without extension	20-45 l/min.

04	DO2922EE04008	Right	Without extension	20-45 l/min.
04	DO2928EE04009	Left	With flat extension - also for joystick	20-45 l/min.
04	DO2928EE04012	Right	With flat extension - also for joystick	20-45 l/min.
05	DO2921EE05008	Left	With extension	Standard
05	DO2921EE05010	Right	With extension	Standard
05	DO2922EE05000	Left	With extension	20-45 l/min.
05	DO2922EE05002	Right	With extension	20-45 l/min.
05	DO2922EE05001	Left	With extension	8-20 l/min.
05	DO2922EE05003	Right	With extension	8-20 l/min.
05	DO2922EE05005	Left	Without extension	20-45 l/min.
05	DO2922EE05006	Right	Without extension	20-45 l/min.
05	DO2928EE05007	Left	With flat extension- also for joystick	20-45 l/min.
05	DO2928EE05008	Right	With flat extension- also for joystick	20-45 l/min.
07	DO2922EE07000	Left	With extension	Standard
07	DO2926EE07003	Left	With flat extension - also for joystick	Standard
07	DO2928EE07003	Left	With flat extension- also for joystick	Standard
70	DO2922EE70000	Right	With extension	Standard
08	DO2928EE08000	Left	With flat extension - also for joystick	20-45 l/min.
10	DO2928EE10000	Left	With flat extension - also for joystick	20-45 l/min.
10	DO2922EE10003	Left	With extension	8-20 l/min
10	DO2922EE10004	Right	With extension	8-20 l/min
10	DO2921EE10005	Left	With extension	Standard

Le spole standard hanno un trattamento di nitro-carburazione. Su richiesta è disponibile anche il trattamento di nichelatura, particolarmente indicato per applicazioni in cui le spole sono esposte ad agenti atmosferici aggressivi.

The standard spools have nitro-carburetion plus hardening treatment. On demand is available also the nickel-plated treatment specially indicate for the applications where the spools are exposed to aggressive atmospheric agents.



Appendici spole / *Spool extensions*

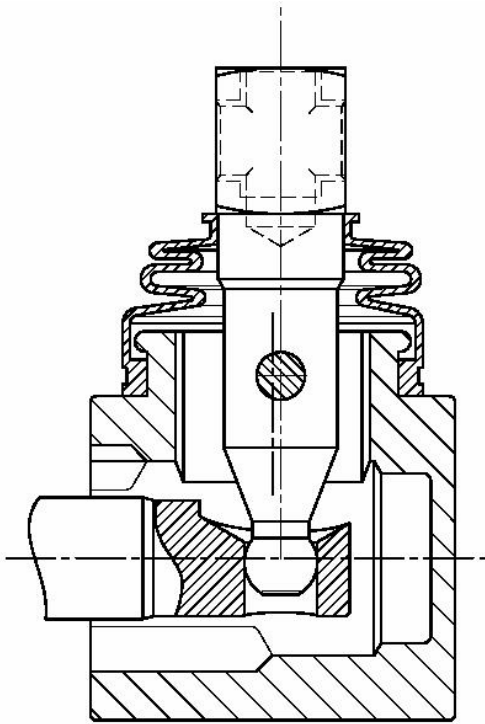

Eye type extension

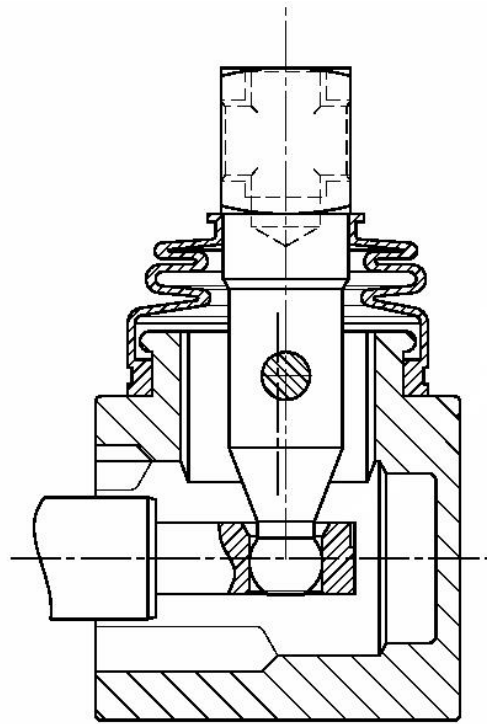

Flat extension







Posizionatori / Spool controls

Codice con casella grigia è fuori standard / Code with grey box is not a standard solution

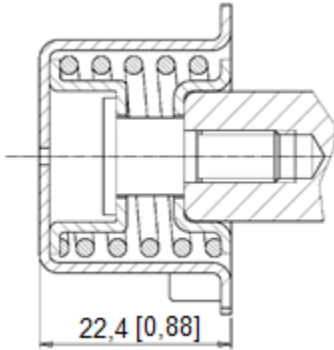
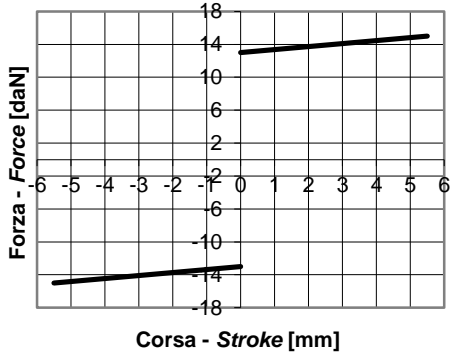
Le forze sono misurate sull'asse spola in condizioni di lavoro, senza flusso di olio. Le forze includono l'attrito e hanno una tolleranza $\pm 10\%$ (norma di riferimento DVCIPS09)

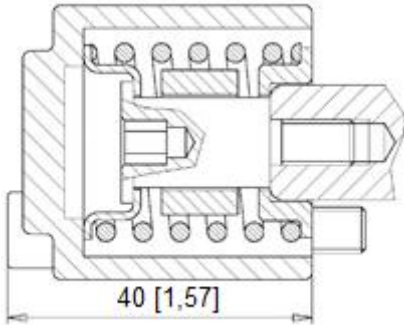
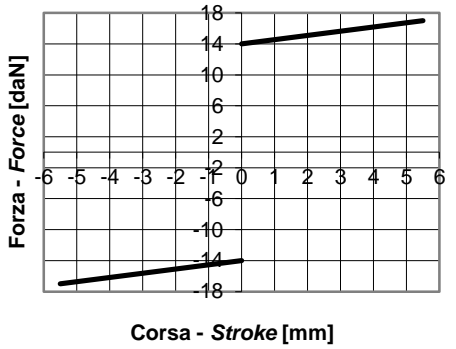
Actuator forces are measured on spool axis in working conditions, with no oil flow. Forces are inclusive of friction and have $\pm 10\%$ tolerance (Test norms ref. DVCIPS09).

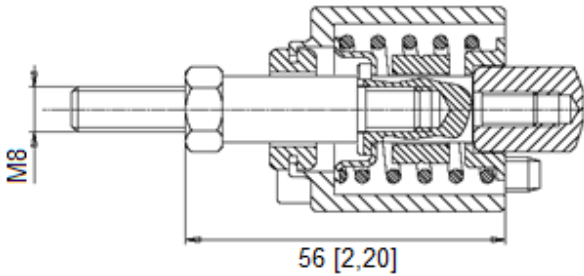
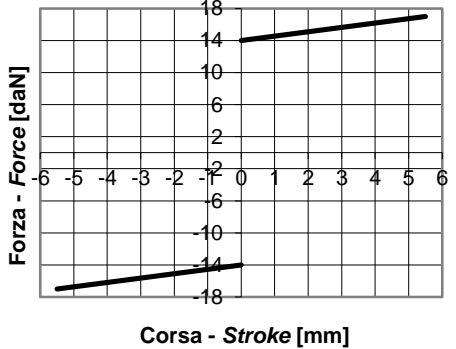
Scheme	code	Section
DO580550A20 Posizionatore standard Standard spool control. 	0A	 
DO580550A40 	0A	 
DO580550A58 	0A	 



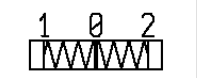
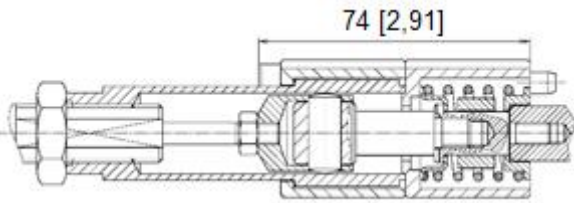
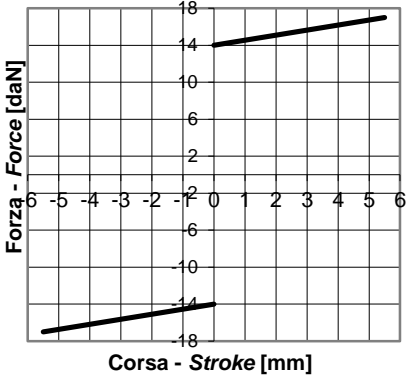
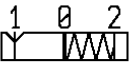
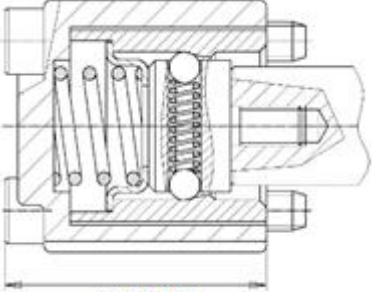
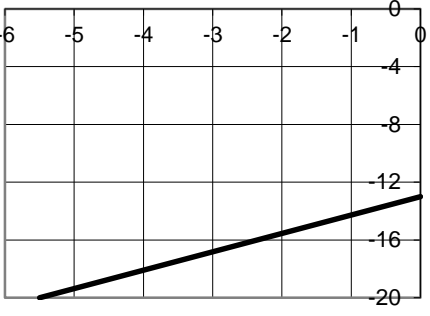
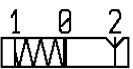
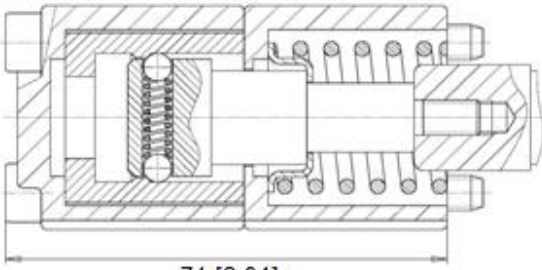
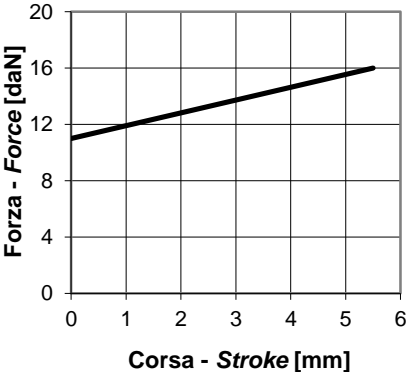
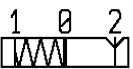
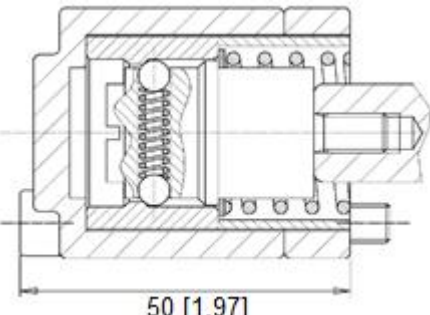
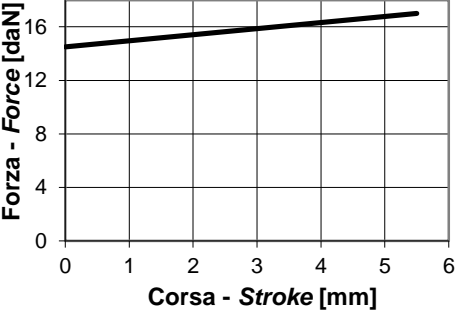

<p>DO580550A54</p> <p>Per controllo con cavo flessibile For flexible cable control</p> 	<p>0A</p>	 <p>Note: forces do not include cable contribution.</p>	 <table border="1"> <caption>Force vs Stroke for Valve 0A</caption> <thead> <tr> <th>Corsa - Stroke [mm]</th> <th>Forza - Force [daN]</th> </tr> </thead> <tbody> <tr><td>-6</td><td>-14</td></tr> <tr><td>-4</td><td>-12</td></tr> <tr><td>-2</td><td>-10</td></tr> <tr><td>0</td><td>-8</td></tr> <tr><td>2</td><td>-6</td></tr> <tr><td>4</td><td>-4</td></tr> <tr><td>6</td><td>-2</td></tr> </tbody> </table>	Corsa - Stroke [mm]	Forza - Force [daN]	-6	-14	-4	-12	-2	-10	0	-8	2	-6	4	-4	6	-2
Corsa - Stroke [mm]	Forza - Force [daN]																		
-6	-14																		
-4	-12																		
-2	-10																		
0	-8																		
2	-6																		
4	-4																		
6	-2																		
<p>DO580550B07</p> 	<p>0B</p>	 <p>Forza aggancio / Hooking force = 22 daN Forza sgancio / Unhooking force = 27 daN</p>	 <table border="1"> <caption>Force vs Stroke for Valve 0B</caption> <thead> <tr> <th>Corsa - Stroke [mm]</th> <th>Forza - Force [daN]</th> </tr> </thead> <tbody> <tr><td>-6</td><td>-18</td></tr> <tr><td>-4</td><td>-16</td></tr> <tr><td>-2</td><td>-14</td></tr> <tr><td>0</td><td>-12</td></tr> <tr><td>2</td><td>-10</td></tr> <tr><td>4</td><td>-8</td></tr> <tr><td>6</td><td>-6</td></tr> </tbody> </table>	Corsa - Stroke [mm]	Forza - Force [daN]	-6	-18	-4	-16	-2	-14	0	-12	2	-10	4	-8	6	-6
Corsa - Stroke [mm]	Forza - Force [daN]																		
-6	-18																		
-4	-16																		
-2	-14																		
0	-12																		
2	-10																		
4	-8																		
6	-6																		
<p>DO580550C08</p> 	<p>0C</p>	 <p>Forza aggancio / Hooking force = 30 daN Forza sgancio / Unhooking force = 20 daN</p>	 <table border="1"> <caption>Force vs Stroke for Valve 0C</caption> <thead> <tr> <th>Corsa - Stroke [mm]</th> <th>Forza - Force [daN]</th> </tr> </thead> <tbody> <tr><td>0</td><td>11</td></tr> <tr><td>1</td><td>12</td></tr> <tr><td>2</td><td>13</td></tr> <tr><td>3</td><td>14</td></tr> <tr><td>4</td><td>15</td></tr> <tr><td>5</td><td>16</td></tr> <tr><td>6</td><td>17</td></tr> </tbody> </table>	Corsa - Stroke [mm]	Forza - Force [daN]	0	11	1	12	2	13	3	14	4	15	5	16	6	17
Corsa - Stroke [mm]	Forza - Force [daN]																		
0	11																		
1	12																		
2	13																		
3	14																		
4	15																		
5	16																		
6	17																		
<p>DO580550C03</p> 	<p>0C</p>	 <p>Forza aggancio / Hooking force = 30 daN Forza sgancio / Unhooking force = 20 daN</p>	 <table border="1"> <caption>Force vs Stroke for Valve 0C</caption> <thead> <tr> <th>Corsa - Stroke [mm]</th> <th>Forza - Force [daN]</th> </tr> </thead> <tbody> <tr><td>0</td><td>14</td></tr> <tr><td>1</td><td>14.5</td></tr> <tr><td>2</td><td>15</td></tr> <tr><td>3</td><td>15.5</td></tr> <tr><td>4</td><td>16</td></tr> <tr><td>5</td><td>16.5</td></tr> <tr><td>6</td><td>17</td></tr> </tbody> </table>	Corsa - Stroke [mm]	Forza - Force [daN]	0	14	1	14.5	2	15	3	15.5	4	16	5	16.5	6	17
Corsa - Stroke [mm]	Forza - Force [daN]																		
0	14																		
1	14.5																		
2	15																		
3	15.5																		
4	16																		
5	16.5																		
6	17																		

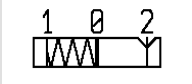
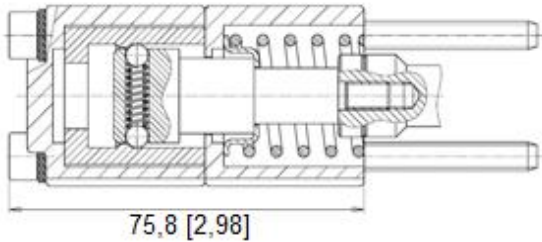
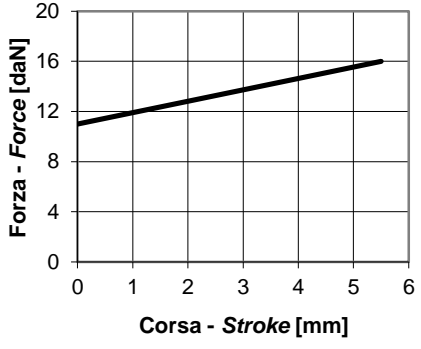
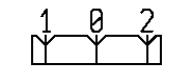
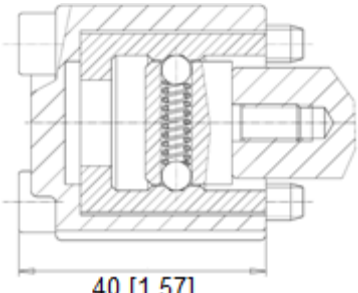
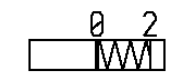
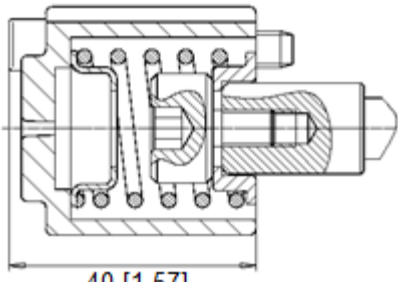
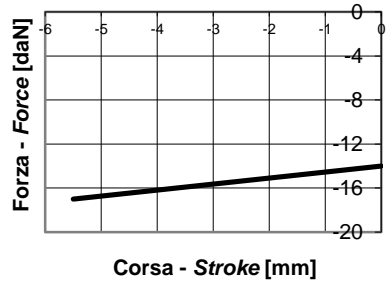
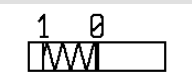
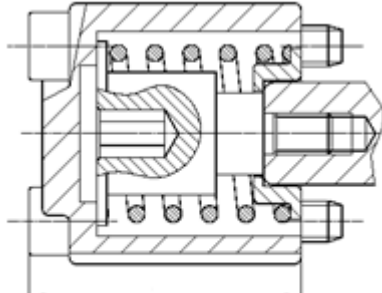
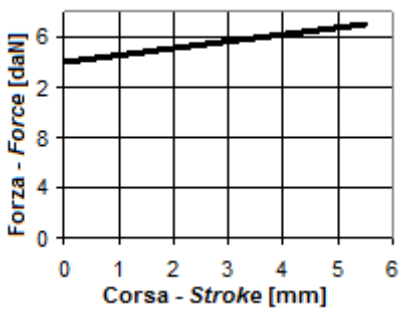



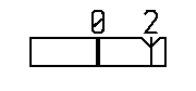
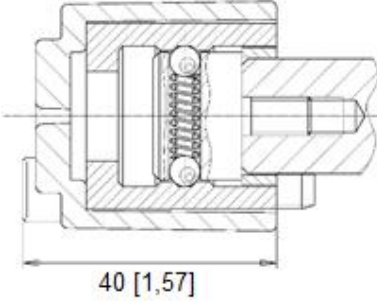
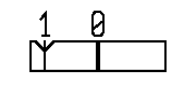
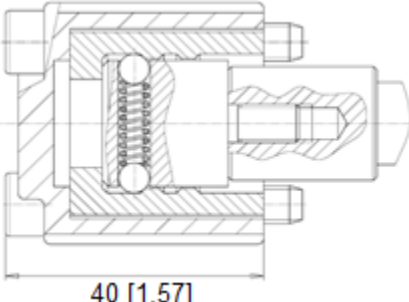

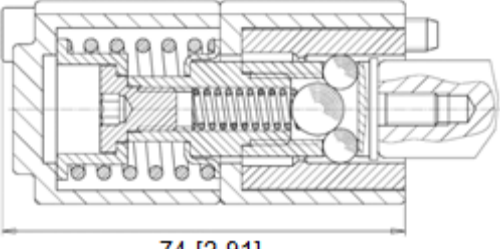
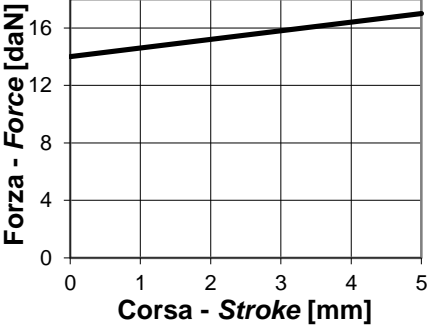
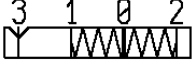
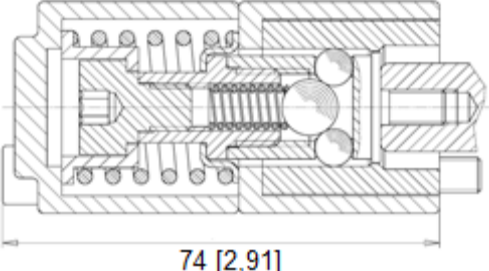
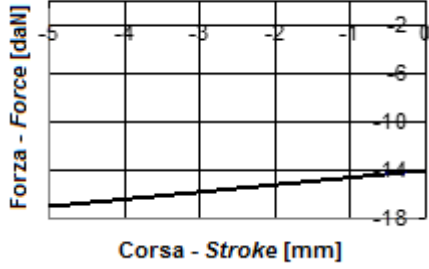
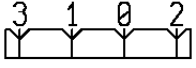
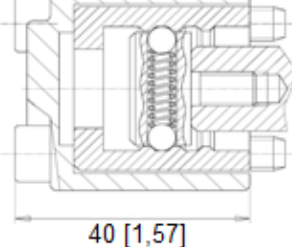
<p>DO580550C10</p> <p>Per singola sezione predisposto micro For single section micro predisposition</p> 	<p>0C</p>	 <p>75,8 [2,98]</p> <p>Forza aggancio / <i>Hooking force</i> = 30 daN Forza sgancio / <i>Unhooking force</i> = 20 daN</p>	
<p>DO580550D01</p> 	<p>0D</p>	 <p>40 [1,57]</p> <p>Forza aggancio / <i>Hooking force</i> = 27 daN Forza sgancio / <i>Unhooking force</i> = 27 daN</p>	
<p>DO580550E05</p> 	<p>0E</p>	 <p>40 [1,57]</p>	
<p>DO580550F05</p> 	<p>0F</p>	 <p>40 [1,57]</p>	



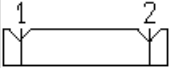
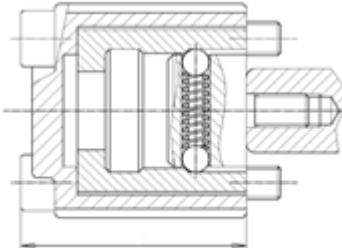

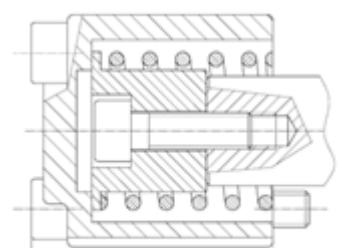
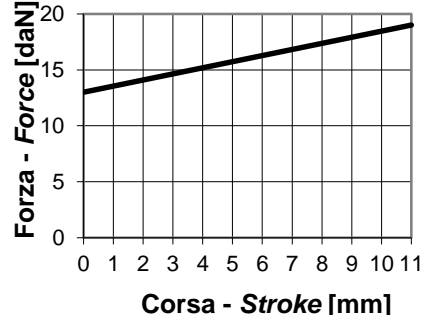
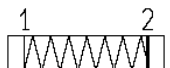
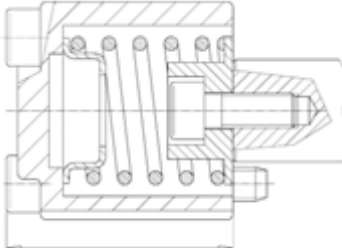
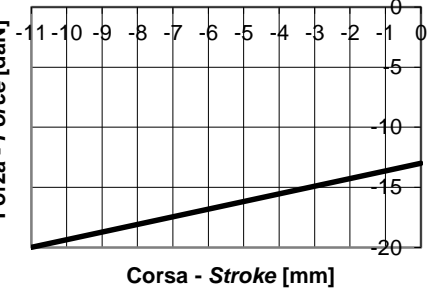

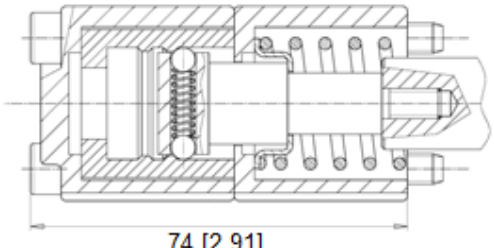
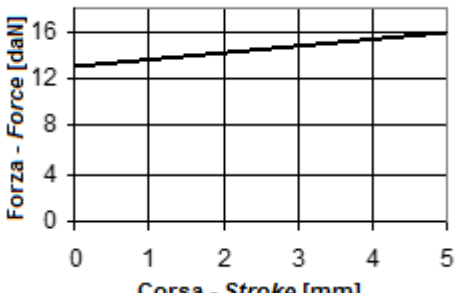
<p>DO580550H02</p> 	<p>OH</p>	 <p>40 [1,57]</p>	<p>Forza aggancio / <i>Hooking force</i> = 27 daN Forza sgancio / <i>Unhooking force</i> = 27 daN</p>
<p>DO580550L01</p> 	<p>OL</p>	 <p>40 [1,57]</p>	<p>Forza aggancio / <i>Hooking force</i> = 27 daN Forza sgancio / <i>Unhooking force</i> = 27 daN</p>
<p>DO580550N20</p> 	<p>NT</p>	 <p>74 [2,91]</p>	
<p>DO580550N14</p> 	<p>NS</p>	 <p>74 [2,91]</p>	
<p>DO580550P01</p> 	<p>PS</p>	 <p>40 [1,57]</p>	<p>Forza aggancio / <i>Hooking force</i> = 27 daN Forza sgancio / <i>Unhooking force</i> = 27 daN</p>



<p>DO580550Q01</p> 	<p>0Q</p>	 <p>40 [1,57]</p>	<p>Forza aggancio / <i>Hooking force</i> = 23 daN Forza sgancio / <i>Unhooking force</i> = 23 daN</p>
<p>DO580550R10</p> 	<p>0R</p>	 <p>40 [1,57]</p>	 <p>Forza - Force [daN]</p> <p>Corsa - Stroke [mm]</p>
<p>DO580550S10</p> 	<p>0S</p>	 <p>40 [1,57]</p>	 <p>Forza - Force [daN]</p> <p>Corsa - Stroke [mm]</p>
<p>DO58055CP02</p> 	<p>CP</p>	 <p>74 [2,91]</p> <p>Forza aggancio / <i>Hooking force</i> = 40 daN Forza sgancio / <i>Unhooking force</i> = 20 daN</p>	 <p>Forza - Force [daN]</p> <p>Corsa - Stroke [mm]</p>

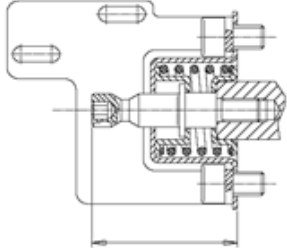

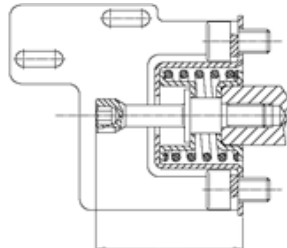
Posizionatori speciali / *Special spool controls*

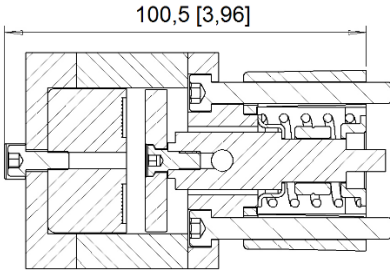
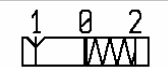
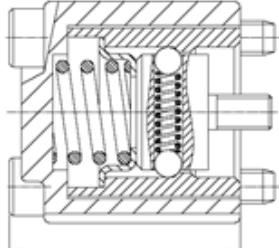
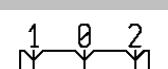
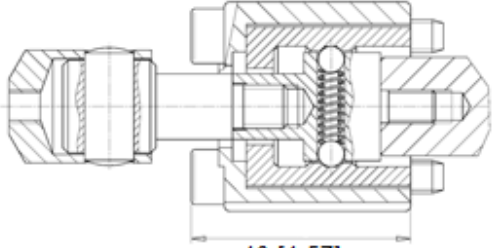
<p>DO580550A49</p> <p>For D.A. micro predisposed</p> 	<p>0A</p>	 <p>37,4 [1,47]</p>
<p>DO580550A50</p> <p>For D.A. in port B micro predisposed</p> 	<p>0A</p>	 <p>37,4 [1,47]</p>
<p>DO580550A63</p> <p>With electromagnetic detent</p> 	<p>0A</p>	 <p>100,5 [3,96]</p>
<p>DO580550B02</p> <p>For aluminum die casting spool control cap</p> 	<p>0B</p>	 <p>40 [1,57]</p>
<p>DO580550D08</p> <p>For flexible cable control</p> 	<p>0D</p>	 <p>40 [1,57]</p> <p>Forza aggancio / <i>Hooking force</i> = 27 daN Forza sgancio / <i>Unhooking force</i> = 27 daN</p>

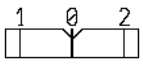
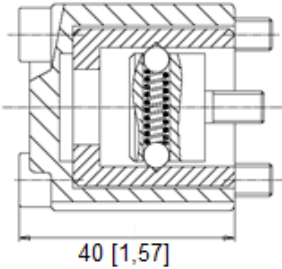
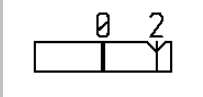
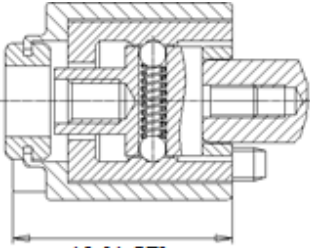
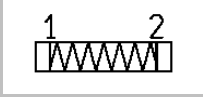
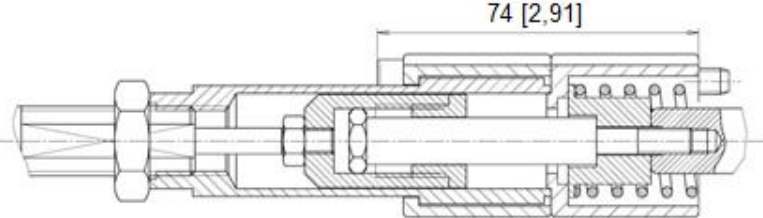
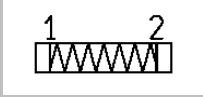
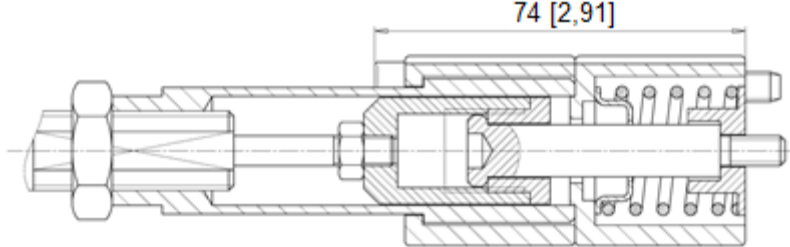

<p>DO58055DF01</p> <p>Frictioned spool control</p> 	<p>DF</p>	 <p>40 [1,57]</p>
<p>DO580550H07</p> <p>For double control</p> 	<p>0H</p>	 <p>40 [1,57]</p>
<p>DO580550R12</p> <p>For flexible cable control</p> 	<p>0R</p>	 <p>74 [2,91]</p>
<p>DO580550S13</p> <p>For flexible cable control</p> 	<p>0S</p>	 <p>74 [2,91]</p>



Compatibilità spole-posizionatore / Spool controls compatibility chart

Circuit	0A	0B	0C	0D	0E	0F	0H	0L	NT	NS	PS	0Q	0R	0S	CPT
01	■	■	■	■	□	□	□	□	X	X	X	■	■	■	X
03	■	■	■	■	■	■	■	■	X	X	X	□	■	■	X
04	■	■	□	■	□	□	□	□	X	X	X	□	□	□	X
05	■	□	■	■	□	□	□	□	X	X	X	□	□	□	X
07	X	X	X	X	X	X	X	X	X	■	■	X	X	X	X
70	X	X	X	X	X	X	X	X	■	X	X	X	X	X	■
08	■	■	■	■	■	X	■	X	X	X	X	□	□	□	X
10	■	■	■	■	X	■	X	■	X	X	X	□	□	□	X

Legend: ■ = available □ = not advised x = not available

Compatibilità azionamento-spole / Actuator compatibility chart

Actuators	Spool type							
	01	03	04	05	07	08	10	70
L Manuale <i>Manual</i>	■	■	■	■	■	■	■	■
Z Manuale con limitatore di corsa <i>Manual with stroke limiter</i>	■	■	■	■	■	■	■	■
A Senza portaleva, appendice standard <i>Without lever holder standard appendix</i>	■	■	■	■	■	■	■	■
B Senza portaleva, senza appendice <i>Without lever holder without appendix</i>	■	■	■	■	■	■	■	■
C Senza portaleva, appendice piatta <i>Without lever holder flat appendix</i>	■	■	■	■	■	■	■	■
T Predisposizione cavo lato azionamento <i>Cable setting on actuator side</i>	■	■	■	■	■	■	■	■
V Intenzionale verticale <i>Intentional vertical</i>	■	■	■	■	x	■	■	x
O Intenzionale orizzontale <i>Intentional horizontal</i>	■	■	■	■	x	■	■	x
M Manipolatore <i>Joystick</i>	■	■	■	■	■	■	■	■
G Manipolatore con blocca spole <i>Manipulator with spool block</i>	■	■	■	■	■	■	■	■
K Comando idraulico <i>Hydraulic control</i>	■	■	■	■	x	■	■	x
P Comando pneumatico <i>Pneumatic control</i>	■	■	■	■	x	■	■	x
Legend: ■ = available x = not available								

Valvola limitatrice di pressione per bocche A-B / Relief valve for port A-B

L'impostazione standard si riferisce a 5 l/min \pm 10% della portata, le pressioni sono fissate a multipli di 10 bar

Standard setting is referred to 5 l/min \pm 10% of flow rate, setting pressures are multiples of 10 bar

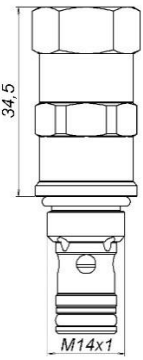
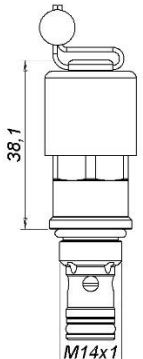
Tipo / Type		Codice di ordinazione Ordering code		Pressione di esercizio Operating pressure
		Codice tipo Type code	Codice pressione Pressure code	
DOWLP02M14--- C – cappuccio C – cap		02	X (50)	20–50 bar (standard setting 50 bar)
			Y (150)	60–150 bar (standard setting 150 bar)
			Z (250)	160–250 bar (standard setting 250 bar)
DOWLP20M14--- P – piombata P – lead sealed		20	X (50)	20–50 bar (standard setting 50 bar)
			Y (150)	60–150 bar (standard setting 150 bar)
			Z (250)	160–250 bar (standard setting 250 bar)

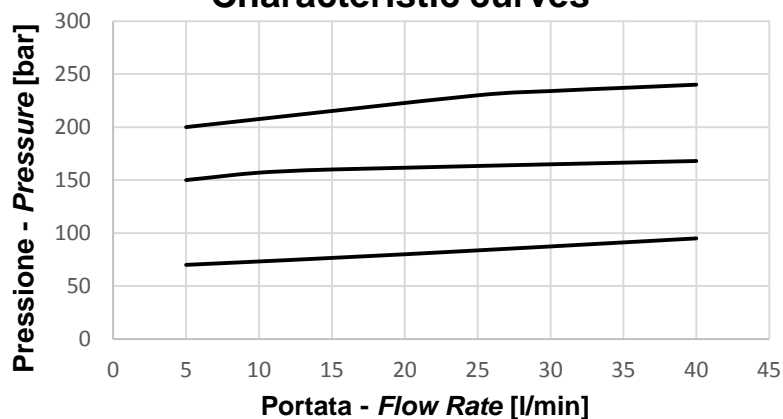
 Curve caratteristiche
 Characteristic curves

 Caratteristiche valvola limitatrice di pressione
 Relief valve characteristics

Portata nominale Nominal flow rate	40 l/min
Cavità Cavity	LDIME019
Coppia di serraggio Tightening torque	18 \pm 2 Nm

Parametri di prova / Oil Testing Parameters: 50 °C – 21 cSt



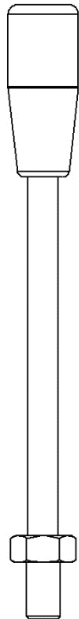

Opzioni leva / Lever options

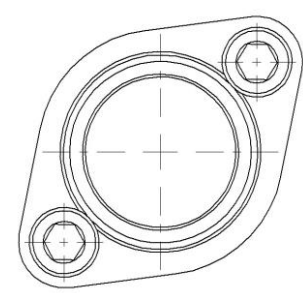
		L [mm]	Codice leva Lever code	
Dritta, leva standard <i>Straight, standard lever</i>		84		DO535108002
		104		DO535110002
		109	A	DO535110502
		134	B	DO535113002
		154		DO535115002
		184	C	DO535118002
		214	D	DO535121002
		254	E	DO535125002
		304	F	DO535130002
		354		DO535135002
		404		DO535140002
		454		DO535145002
		504		DO535150002
		604		DO535160002
		674		DO535167002

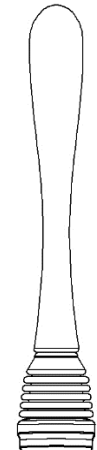
P	
	<p>Parapolvere / <i>Wiper seal</i></p> <p>Disponibile solo per azionamento A, B, C <i>Available only for actuator A, B, C</i></p> <p>Pagine / <i>Pages</i>: 19-20</p>

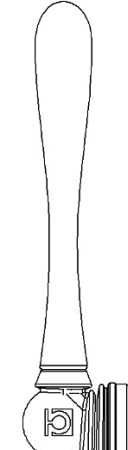
L		<p>DO535199901</p> <p>Leva ergonomica, dritta <i>Ergonomic straight lever</i></p> <p>M10, 180 mm</p>
----------	---	--

M		<p>DO535199912</p> <p>Leva ergonomica, ruotata 90° <i>Ergonomic 90° rotated straight lever</i></p> <p>M10, 180 mm</p>
----------	--	---

O		<p>DO535199902</p> <p>Leva ergonomica, piegata 15° <i>Ergonomic 15° bent lever</i></p> <p>M10, 180 mm</p>
----------	---	---

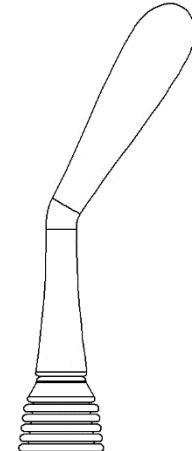
R		<p>DO535199903</p> <p>Leva ergonomica, piegata 30° <i>Ergonomic 30° bent lever</i></p> <p>M10, 180 mm</p>
----------	--	---



Opzioni lato posizionatore / Options spool control side

<p>DO5753703</p> <p>Kit limitatore di corsa spola <i>Kit stroke limiter on spool control side</i></p>	<p>C</p>	
<p>DO580550A58</p> <p>Doppio comando maschio <i>Male double control</i></p>	<p>M</p>	
<p>DO580550A48</p> <p>Doppio comando femmina <i>Female double control</i></p>	<p>F</p>	
<p>DO580550A54</p> <p>Predisposizione cavo <i>Cable setup</i></p>	<p>T</p>	

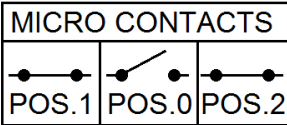
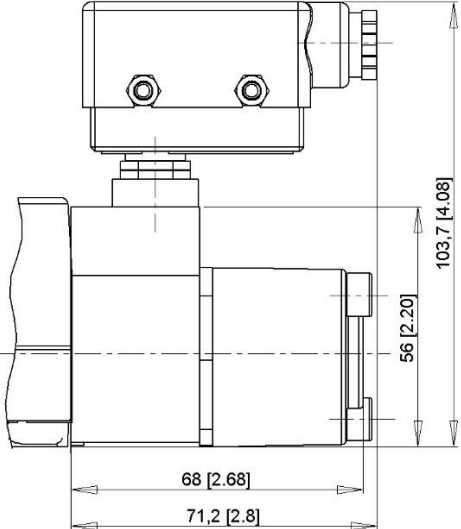
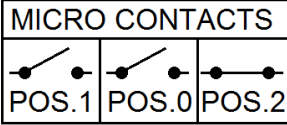
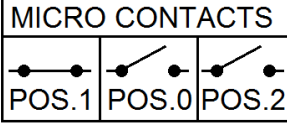

<p>DO56107</p> <p>Micro doppio effetto <i>Dual effect microswitch</i></p>	<p>Y</p>	<p>MICRO CONTACTS</p> 	
<p>DO56113</p> <p>Micro semplice effetto bocca A <i>Simple effect microswitch port A</i></p>	<p>P</p>	<p>MICRO CONTACTS</p> 	
<p>DO56114</p> <p>Micro semplice effetto bocca B <i>Simple effect microswitch port B</i></p>	<p>O</p>	<p>MICRO CONTACTS</p> 	

Per micro, usare posizionatore / For micro, use spool control: DO580550A39

<p>Caratteristiche Micro / Micro characteristics</p>	
<p>Portata dei contatti / <i>Contact rating</i></p>	<p>16(5)A at 250V A.C 50Hz. – 3A at 30V D.C. L/R=5ms</p>
<p>Temperatura di funzionamento / <i>Operating temperature</i></p>	<p>-20° to 85° C</p>
<p>Vita meccanica attesa / <i>Expected mechanical life</i></p>	<p>10 million operations at 1Hz</p>
<p>Isolamento / <i>Initial insulation</i></p>	<p>Up to 100 MΩ</p>

Filettature bocche T – T1 / Thread port T – T1

Codice filettatura <i>Thread code</i>	Tipo <i>Type</i>	Serraggio [Nm] <i>Torque [Nm]</i>
A	3/8" GAS ISO 1179	35
B	1/2" GAS ISO 1179	70
T	M16x1,5 ISO 9974	24
C	M18x1,5 ISO 9974	40
I	M16x1,5 ISO 6149	24
W	M18x1,5 ISO 6149	40
P	9/16-18 SAE ISO 11926	21
E	3/4-16 SAE ISO 11926	50

Filettature bocca T4 / Thread port T4

Codice filettatura <i>Thread code</i>	Tipo <i>Type</i>	Serraggio [Nm] <i>Torque [Nm]</i>
0 (Standard)	Non lavorato - <i>Not machined</i>	/
L	1/4" GAS ISO 1179	14
A	3/8" GAS ISO 1179	35
B	1/2" GAS ISO 1179	70
T	M16x1,5 ISO 9974	24
C	M18x1,5 ISO 9974	40
I	M16x1,5 ISO 6149	24
W	M18x1,5 ISO 6149	40
P	9/16-18 SAE ISO 11926	21
E	3/4-16 SAE ISO 11926	50

Opzioni su bocca T – T1 – T4 / Options on port T – T1 – T4

A	T-T1-T4 aperti	<i>T-T1-T4 open</i>
B	T-T1 aperti – T4 non lavorato	<i>T-T1 open – T4 not machined</i>
C	T-T1 aperti – T4 tappato	<i>T-T1 open – T4 plugged</i>
D	T-T4 aperti – T1 tappato	<i>T-T4 open – T1 plugged</i>
E	T aperto – T1 tappato – T4 non lavorato	<i>T open – T1 plugged – T4 not machined</i>
F	T aperto – T1-T4 tappati	<i>T open – T1-T4 plugged</i>
G	T tappato – T1-T4 aperti	<i>T plugged – T1-T4 open</i>
H	T tappato – T1 aperto – T4 tappato	<i>T plugged – T1 open – T4 plugged</i>
I	T tappato – T1 aperto – T4 non lavorato	<i>T plugged – T1 open – T4 not machined</i>
L	T-T1 tappati – T4 aperto	<i>T-T1 plugged – T4 open</i>



Opzioni a scarico / Discharge options

B	Carry over	DO3403001401
----------	------------	---------------------

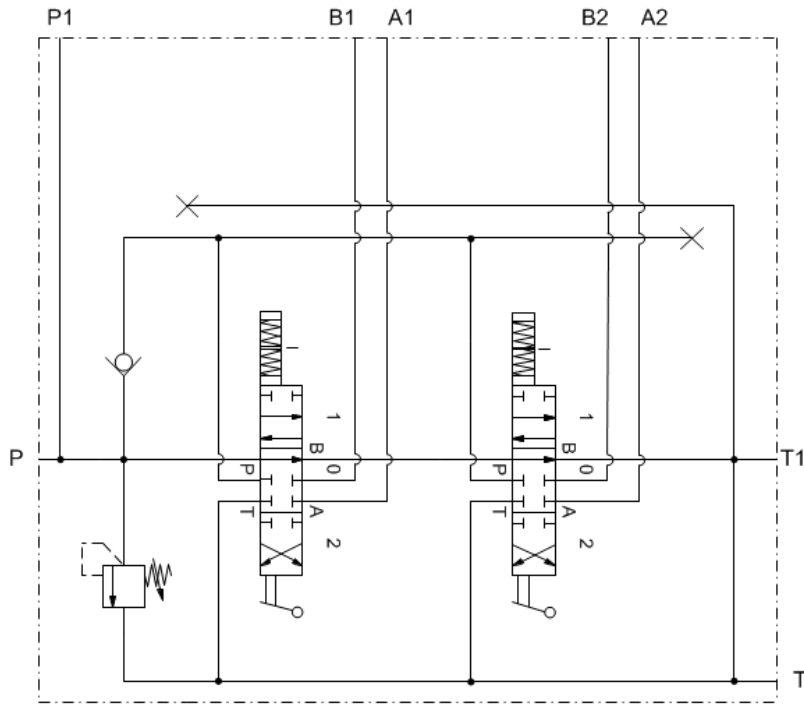

Circuito standard – Standard circuit
(ML2 010A 010A)

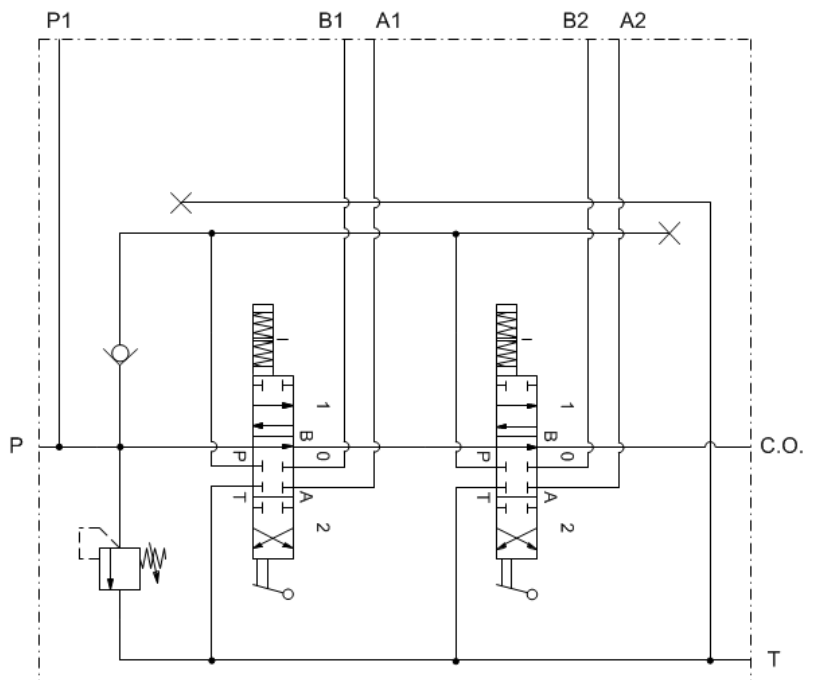
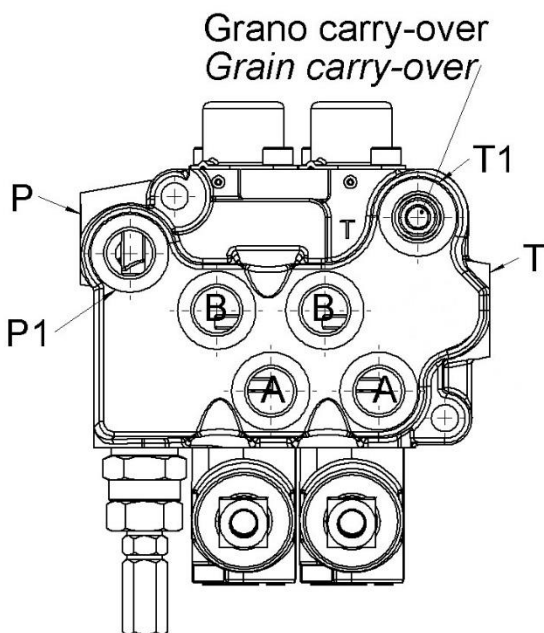

Circuito con Carry over – Circuit with Carry over
(ML2 010A 010A)



Opzioni speciali / *Special options*

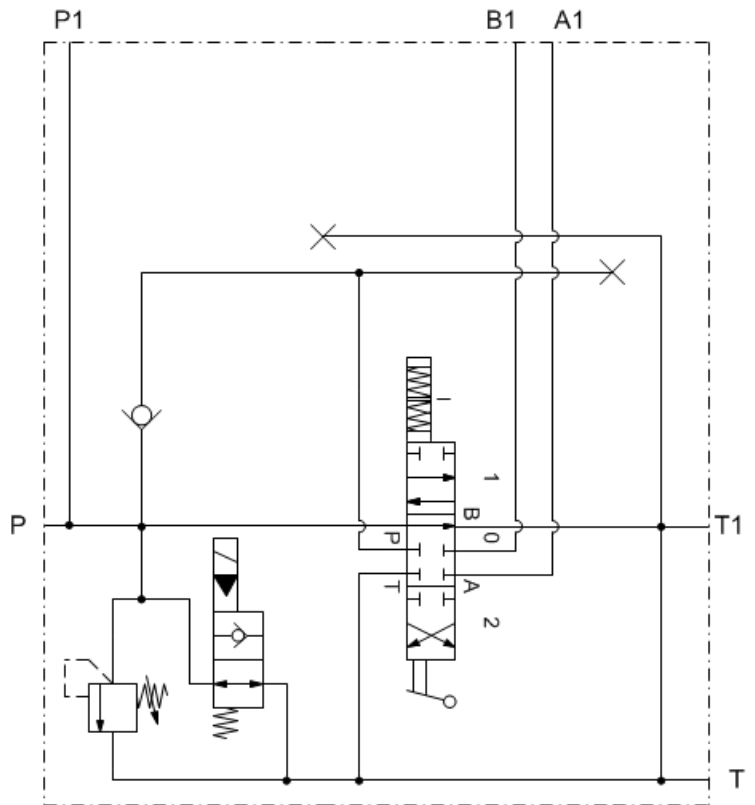
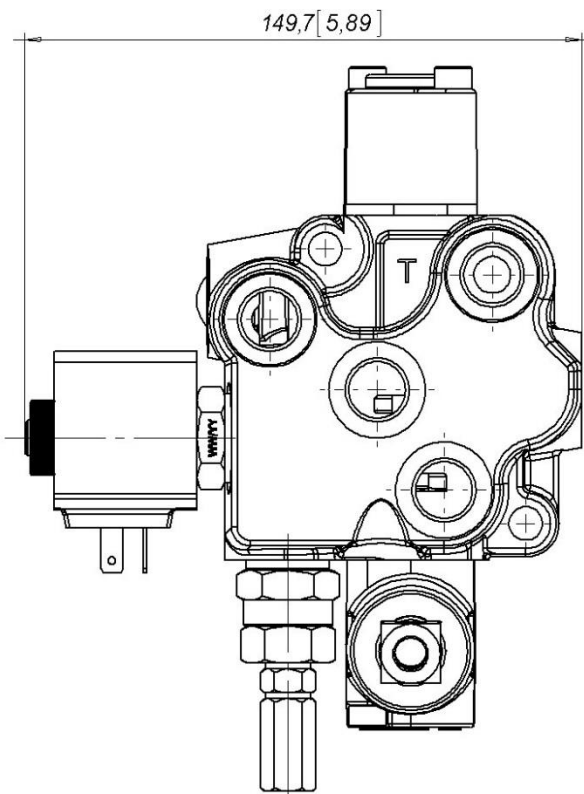

UNL	Valvola di messa a scarico, permette il collegamento diretto della linea P con la linea T <i>Unloading valve, allows the direct connection of the P-line to the T-line</i>
Per questa opzione, è necessario contattare il customer service <i>For this option, it is necessary contact the customer service</i>	



Circuito con UNL – *Circuit with UNL*
(ML1 010A)

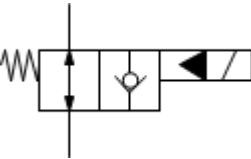
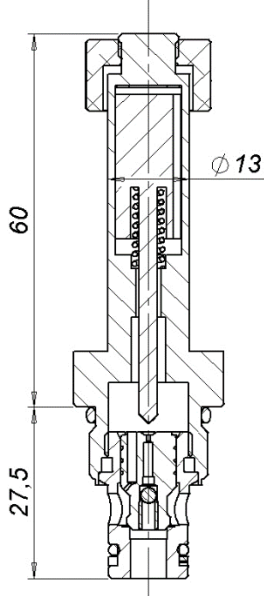

Valvola di messa a scarico / Unloading valve

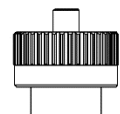
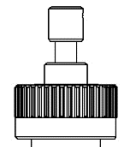
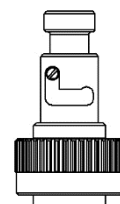
Tipo Type	Disegno Drawing	Tipo di regolazione Regulation type		
Elettrovalvola 2 vie pilotata normalmente aperta <i>Pilot solenoid valve 2 way, normally open</i> SCA 08220 		Terminale standard Standard housing	O	
		Emergenza manuale con ritorno libero <i>Manual override, free-back</i>	M	
		Emergenza a vite <i>Manual override with screw</i>	S	
		Emergenza con blocco Manual override with block	B	
Coppia Torque 27 Nm	Portata nominale Rated flow 35 l/min	Temperatura di utilizzo Operating temperature - 20 / 85 °C NBR Seals - 20 / 130 °C HNBR Seals		Cavità Cavity L0K0001

Curve caratteristiche
Characteristic curves

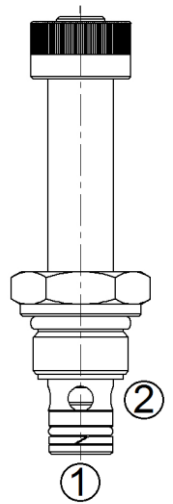
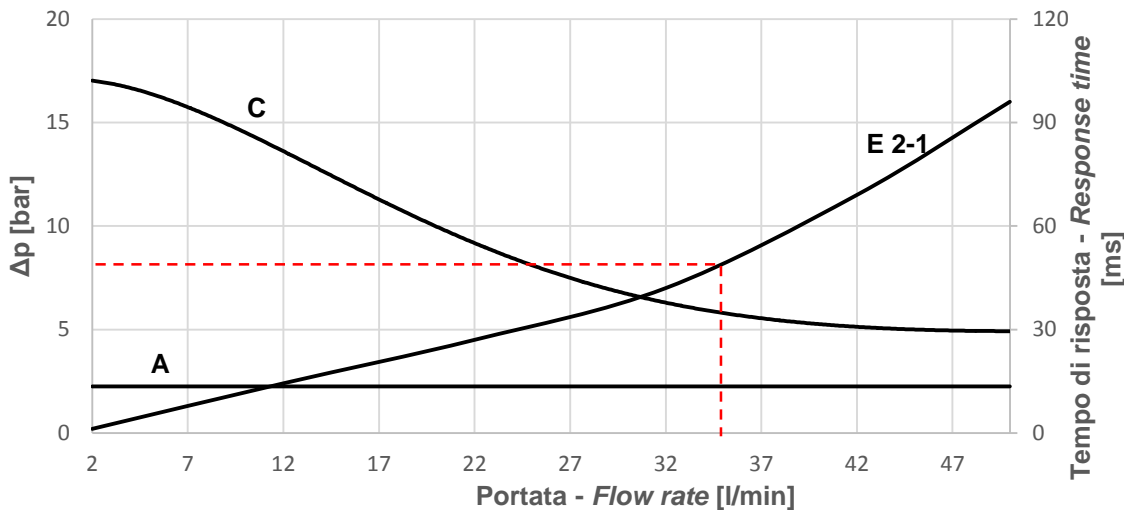

Testing parameters

Oil Testing Parameters: 50 °C – 21 cSt
Coil: C1 18 W, 12 V
Current: 0,94 A

Keys

E 2-1: Δp with energized coil and flow direction 2 – 1
A: response time opening
C: response time closing

Azionamento elettrico per valvola di messa a scarico / *Electric actuator for unloading valve*

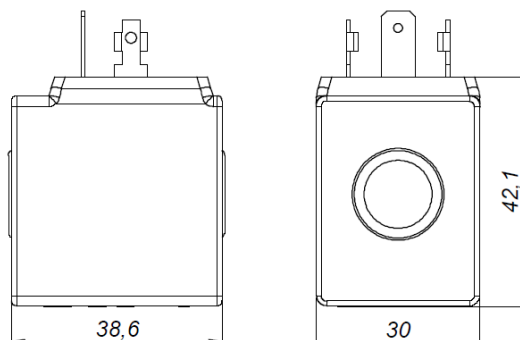
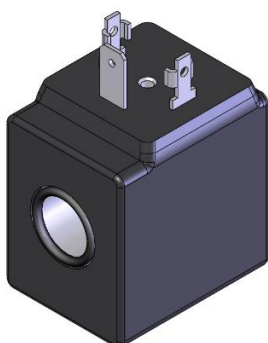

Coppia di serraggio: 27 - 30 Nm

Tightening torque: 27 - 30 Nm

Tensione e connettore / *Voltage and connector*

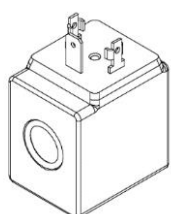
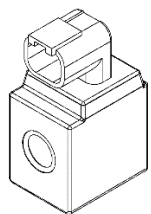
Order code		Description	Drawing
A	DO712012DCD001	DIN 43650-A/ISO4400 12V	
B	DO712024DCD004	DIN 43650-A/ISO4400 24V	
C		AMP SUPER SEAL 12V	Disponibile su richiesta <i>Available on demand</i>
D		AMP SUPER SEAL 24V	
E		AMP JUNIOR 12V	Disponibile su richiesta <i>Available on demand</i>
F		AMP JUNIOR 24V	
G	DO712012DCD023	DEUTSCH DT04-2P 12V	
H	DO712024DCD037	DEUTSCH DT04-2P 24V	

I kit bobina sono comprensivi di OR

The coil kit include the OR



MLVB

Disponibile solo su versione a tre sezioni, permette l'utilizzo sulle bocche A di valvole di blocco idro-pilotate.
Available only on the version with three sections, allows the use of hydro-controlled blocking valves on ports A

Per questa opzione, è necessario contattare il customer service
For this option, it is necessary contact the customer service

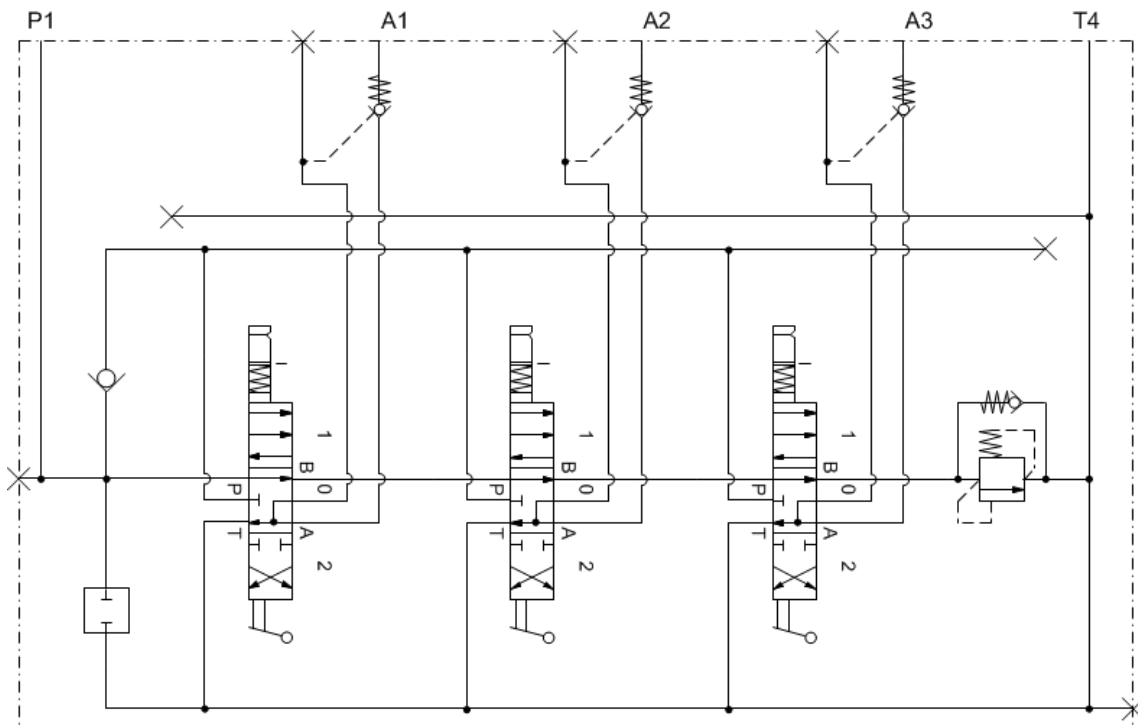
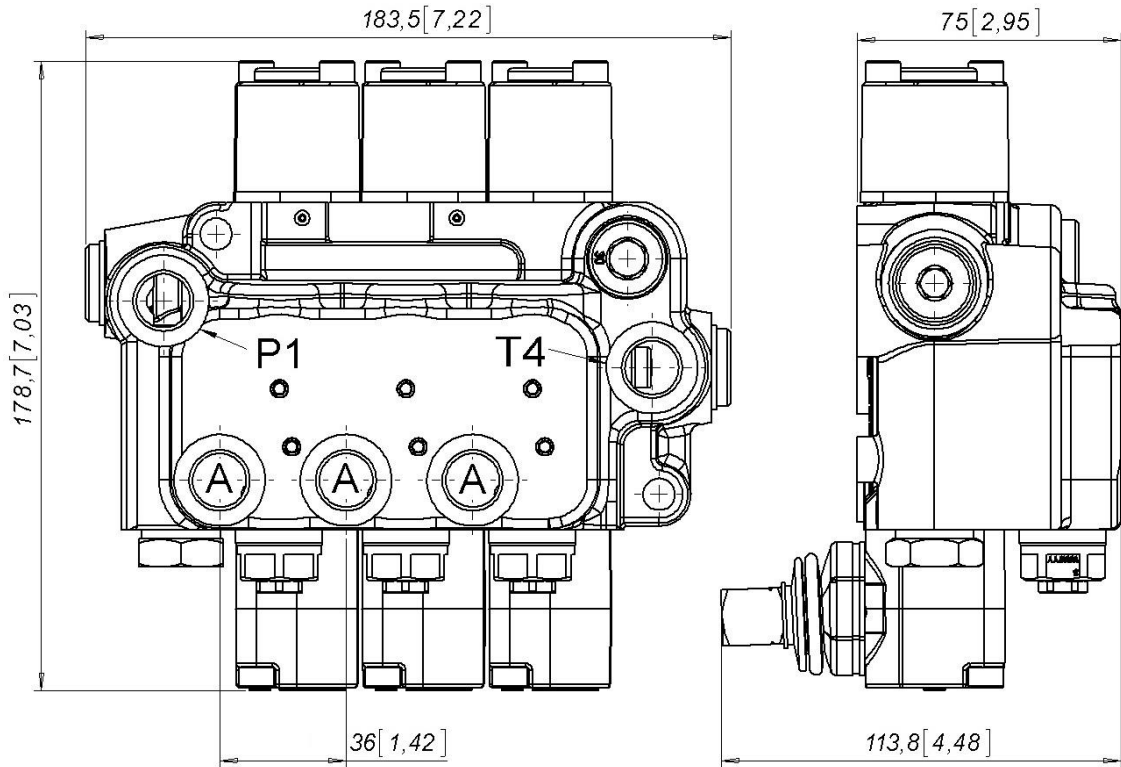



Istruzioni per l'ordinazione / Ordering instructions

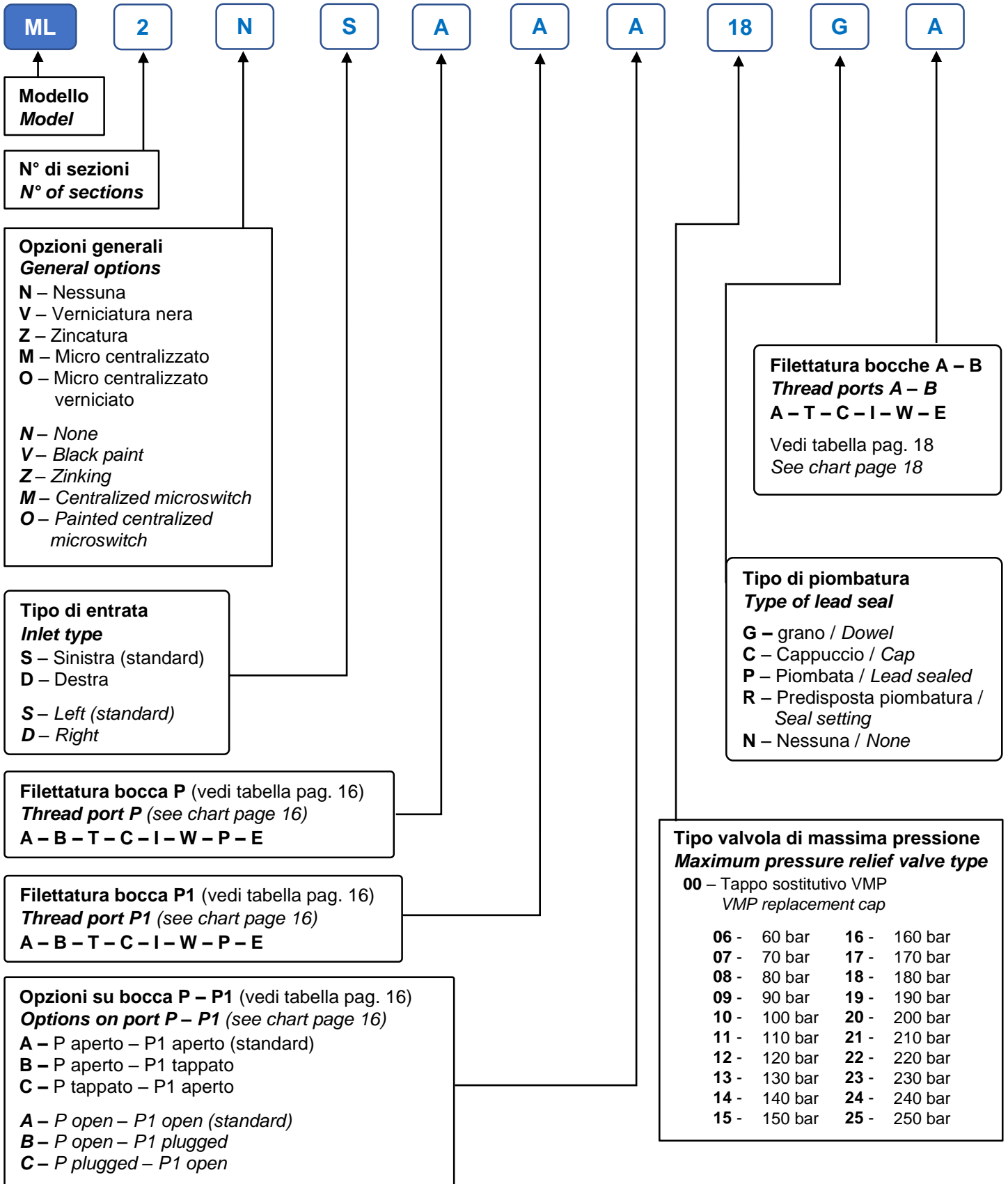



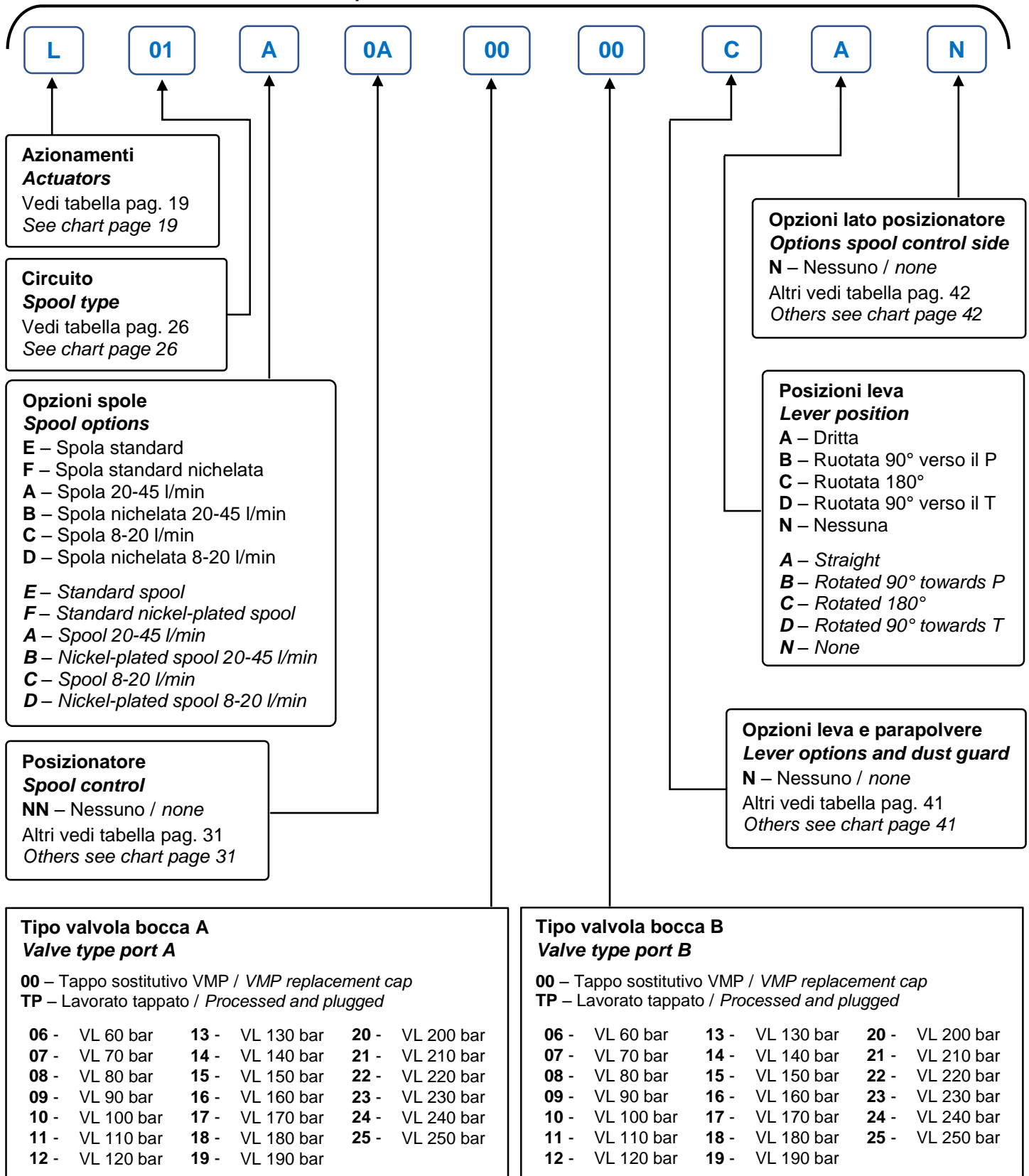

Ripetere per ogni sezione del distributore
Repeat for each section of the distributor

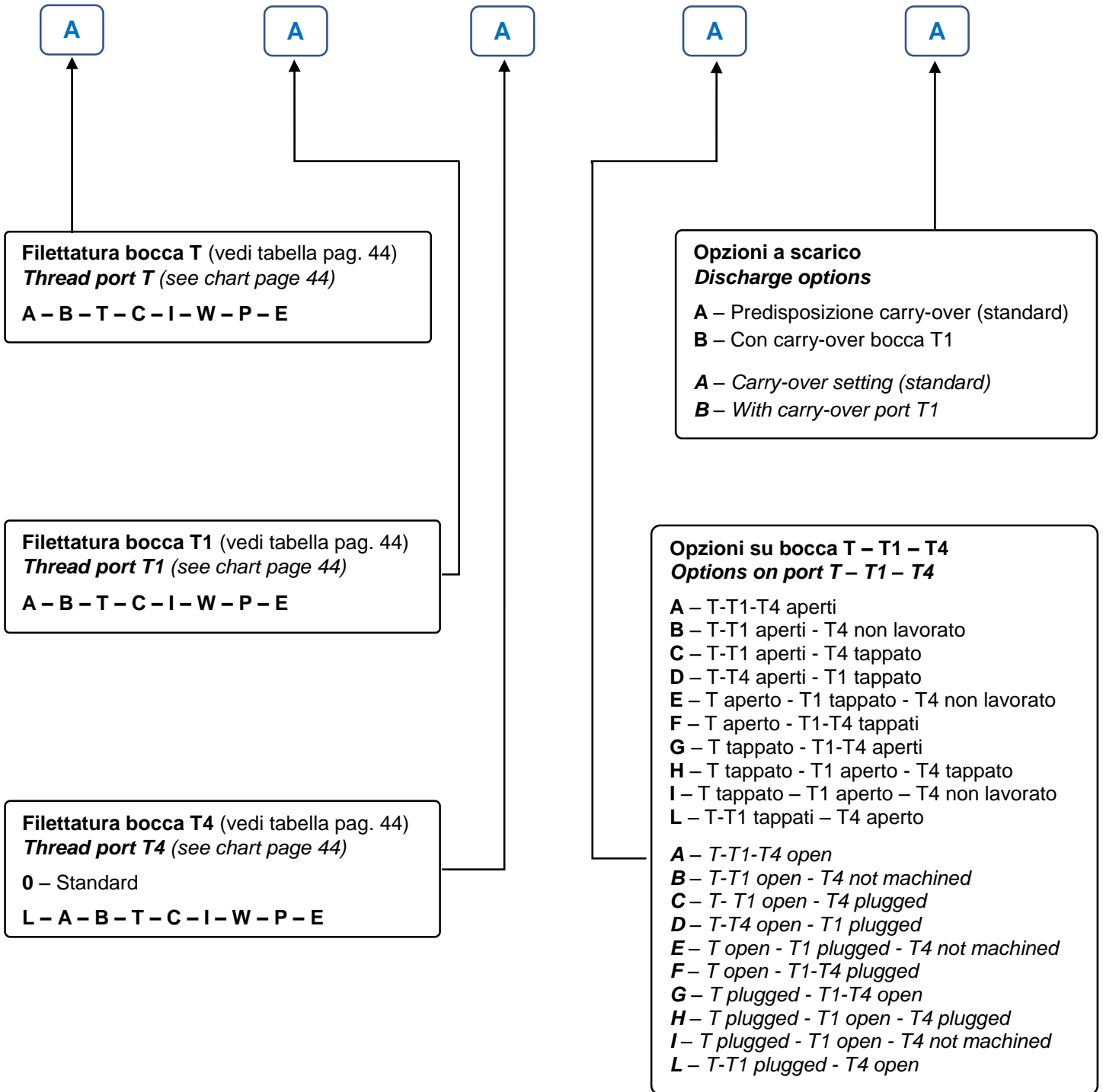



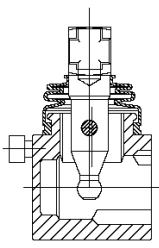
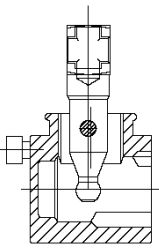
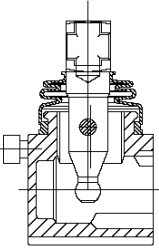

Lista ricambi / Spare part list

Codice Code	Descrizione Description	Disegno sezione Sectional view
DO57010817R h 24	Kit N°1 Portaleva con viti cod. DO57010817 <i>Kit N°1 Housing lever with screws cod. DO57010817</i>	
DO57010817R10 h 24	Kit N°10 Portaleva con viti cod. DO57010817 <i>Kit N°10 Housing lever with screws cod. DO57010817</i>	
DO57013604R h 24	Kit N°1 Portaleva per leve ergonomiche con viti cod. DO57013604 <i>Kit N°1 Housing lever with screws for ergonomic levers cod. DO57013604</i>	
DO57013604R10 h 24	Kit N°10 Portaleva per leve ergonomiche con viti cod. DO57013604 <i>Kit N°10 Housing levers with screws for ergonomic levers cod. DO57013604</i>	
DO57010835R h 24	Kit N°1 Portaleva per leve ergonomiche ruotato di 90° con viti cod. DO57010835 <i>Kit N°1 Housing lever with screws for ergonomic levers 90° rotated cod. DO57010835</i>	
DO57010835R10 h 24	Kit N°10 Portaleva per ruotato di 90° con viti cod. DO57010835 <i>Kit N°10 Housing lever with screws for ergonomic levers 90° rotated cod. DO57010835</i>	
DO535118002R h 24	N° 1 Leva M10 x 180 mm cod. DO535118002 <i>N° 1 Lever M10 x 180 mm cod. DO535118002</i>	
DO535118002R20 h 24	Kit N°20 Leve M10 x 180 mm cod. DO535118002 <i>Kit N°20 Levers M10 x 180 mm cod. DO535118002</i>	
DO535113002R h 24	N° 1 Leva M10 x 130 mm cod. DO535113002 <i>N° 1 Lever M10 x 130 mm cod. DO535113002</i>	
DO535113002R20 h 24	Kit N°20 Leve M10 x 130 mm cod. DO535113002 <i>Kit N°20 Levers M10 x 130 mm cod. DO535113002</i>	

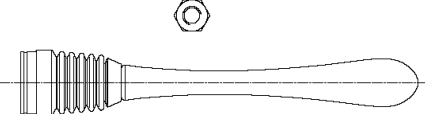
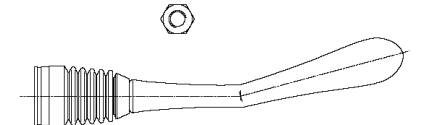
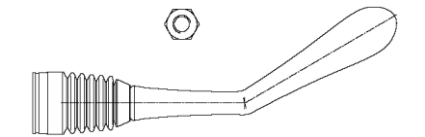

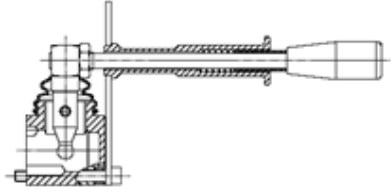
DO535125002R	h 24	N° 1 Leva M10 x 250 mm cod. DO535125002 <i>N° 1 Lever M10 x 250 mm cod. DO535125002</i>	
DO535125002R20	h 24	Kit N°20 Leve M10 x 250 mm cod. DO535125002 <i>Kit N°20 Levers M10 x 250 mm cod. DO535125002</i>	
DO535199901R		N° 1 Leva erg. Dritta cod. DO535199901 <i>N° 1 Erg. Straight lever cod. DO535199901</i>	
DO535199901R20		Kit N°20 Leve erg. Dritte cod. DO535199901 <i>Kit N°20 Erg. straight levers cod. DO535199901</i>	
DO535199902R		N° 1 Leva erg. Piegate 15° cod. DO535199902 <i>N° 1 Erg. 15° bent lever cod. DO535199902</i>	
DO535199902R20		Kit N°20 Leve erg. Piegate 15° cod. DO535199902 <i>Kit N°20 Erg. 15° bent levers cod. DO535199902</i>	
DO535199903R		N° 1 Leva erg. Piegata 30° cod. DO535199903 <i>N° 1 Erg. 30° bent lever cod. DO535199903</i>	
DO535199903R20		Kit N°20 Leve erg. Piegate 30° cod. DO535199903 <i>Kit N°20 Erg. 30° bent levers cod. DO535199903</i>	
DO54036002R		N° 1 Leva intenzionale con viti cod. DO54036002 <i>N° 1 Intentional lever with screws cod. DO54036002</i>	
DO54036002R10		Kit N°10 Leve intenzionali con viti cod. DO54036002 <i>Kit N°10 Intentional levers with screws cod. DO54036002</i>	
DO54036006R		N° 1 Leve intenzionali con piastra orizzontale cod. DO54036006 <i>N° 1 Intentional levers with horizontal plate cod. DO54036006</i>	
DO54036006R10		Kit N°10 Leve intenzionali con piastra orizzontale cod. DO54036006 <i>Kit N°10 Intentional levers with horizontal plate cod. DO54036006</i>	

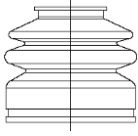
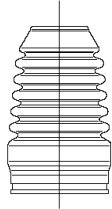
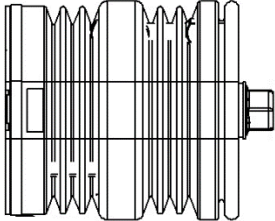
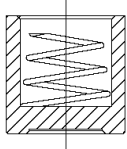

DO28602001R	h 24	N° 1 Soffietto per leva standard <i>N° 1 Hood for standard lever</i>	
DO28602001R20	h 24	Kit N° 20 Soffietti per leva standard <i>Kit N° 20 Hoods for standard lever</i>	
DO28602002R	h 24	N° 1 soffierto per leva ergonomia <i>N° 1 Hood for ergonomic lever</i>	
DO28602002R20	h 24	Kit N° 20 Soffietti per leva ergonomia <i>Kit N° 20 Hoods for ergonomic lever</i>	
DO55513615R		Kit N° 1 Manipolatore cod. DO55513615 (da montare) <i>Kit N° 1 Joystick cod. DO55513615 (to assemble)</i>	
DO55513615R05		Kit N°5 Manipolatori cod. DO55513615 (da montare) <i>Kit N°5 Joysticks cod. DO55513615 (to assemble)</i>	
DOWUS00D13001R		N°1 VNR cod. DOWUS00D13001	
DOWUS00D13001R10		Kit N°10 VNR cod. DOWUS00D13001	

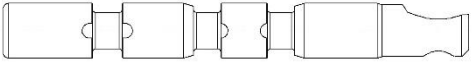
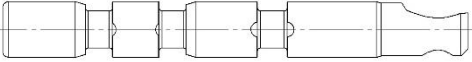
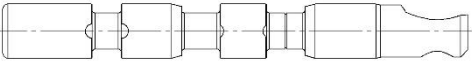
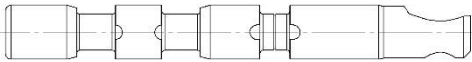
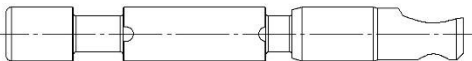
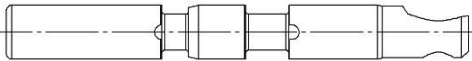

DO2921EE01000R	h 24	N° 1 Spola d. 15 mm ML c.01 entrata sinistra <i>N° 1 Spool d.15 mm ML c.01 left inlet</i>	
DO2921EE01000R05	h 24	Kit N°5 Spole d. 15 mm ML c.01 entrata sinistra <i>Kit N°5 Spools d.15 mm ML c.01 left inlet</i>	
DO2921EE01033R	h 24	N° 1 Spola d. 15 mm ML c.01 entrata destra <i>N°1 Spool d. 15 mm ML c.01 right inlet</i>	
DO2921EE01033R05	h 24	Kit N°5 Spole d. 15 mm ML c.01 entrata destra <i>Kit N°5 Spools d. 15 mm ML c.01 right inlet</i>	
DO2921EE03000R	h 24	N° 1 Spola d. 15 mm ML c.03 entrata sinistra <i>N° 1 Spool d.15 mm ML c.03 left inlet</i>	
DO2921EE03000R05	h 24	Kit N°5 Spole d. 15 mm ML c.03 entrata sinistra <i>Kit N°5 Spools d.15 mm ML c.03 left inlet</i>	
DO2921EE03009R	h 24	N° 1 Spola d. 15 mm ML c.03 entrata destra <i>N° 1 Spool d.15 mm ML c.03 right inlet</i>	
DO2921EE03009R05	h 24	Kit N°5 Spole d. 15 mm ML c.03 entrata destra <i>Kit N°5 Spools d.15 mm ML c.03 right inlet</i>	
DO2921EE04015R	h 24	N° 1 Spola d. 15 mm ML c.04 entrata sinistra <i>N° 1 Spool d.15 mm ML c.04 left inlet</i>	
DO2921EE04015R05	h 24	Kit N°5 Spole d. 15 mm ML c.04 entrata sinistra <i>Kit N°5 Spools d.15 mm ML c.04 left inlet</i>	
DO2921EE04016R	h 24	N° 1 Spola d. 15 mm ML c.04 entrata destra <i>N° 1 Spool d.15 mm ML c.04 right inlet</i>	
DO2921EE04016R05	h 24	Kit N°5 Spole d. 15 mm ML c.04 entrata destra <i>Kit N°5 Spools d.15 mm ML c.04 right inlet</i>	

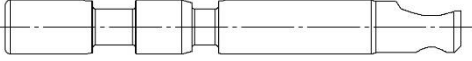
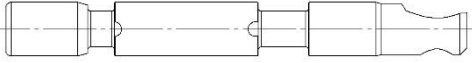
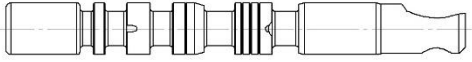
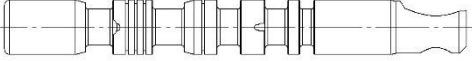

DO2921EE05008R	h 24	N° 1 Spola d. 15 mm ML c.05 entrata sinistra <i>N° 1 Spool d.15 mm ML c.05 left inlet</i>	
DO2921EE05008R05	h 24	Kit N°5 Spole d. 15 mm ML c.05 entrata sinistra <i>Kit N°5 Spools d.15 mm ML c.05 left inlet</i>	
DO2921EE05010R	h 24	N° 1 Spola d. 15 mm ML c.05 entrata destra <i>N° 1 Spool d.15 mm ML c.05 right inlet</i>	
DO2921EE05010R05	h 24	Kit N°5 Spole d. 15 mm ML c.05 entrata destra <i>Kit N°5 Spools d.15 mm ML c.05 right inlet</i>	
DO2922EE07000R	h 24	N° 1 Spola d. 15 mm ML c.07 entrata sinistra 20-45 l/min. <i>N° 1 Spool d.15 mm ML c.07 left inlet 20-45 l/min.</i>	
DO2922EE07000R05	h 24	Kit N°5 Spole d. 15 mm ML c.07 entrata sinistra 20-45 l/min. <i>Kit N°5 Spools d.15 mm ML c.07 left inlet 20-45 l/min.</i>	
DO2922EE70000R	h 24	N° 1 Spola d. 15 mm ML c.70 entrata destra 20-45 l/min. <i>N° 1 Spool d.15 mm ML c.70 right inlet 20-45 l/min.</i>	
DO2922EE70000R05	h 24	Kit N°5 Spole d. 15 mm ML c.70 entrata destra 20-45 l/min. <i>Kit N°5 Spools d.15 mm ML c.70 right inlet 20-45 l/min.</i>	



DO580550A20R	N° 1 Posizionatore cod. DO580550A20 N° 1 Spool control cod. DO580550A20	
DO580550A20R10	Kit N°10 Posizionatori cod. DO580550A20 Kit N°10 Spool controls cod. DO580550A20	
DO580550A40R	N° 1 Posizionatore cod. DO580550A40 N° 1 Spool control cod. DO580550A40	
DO580550A40R10	Kit N°10 Posizionatori cod. DO580550A40 Kit N°10 Spool controls cod. DO580550A40	
DO580550A54R	Kit N°1 Posizionatore cod. DO580550A54 Kit N°1 Spool control cod. DO580550A54	
DO580550A54R10	Kit N°10 Posizionatori cod. DO580550A54 Kit N°10 Spool controls cod. DO580550A54	
DO580550A58R	Kit N°1 Posizionatore cod. DO580550A58 Kit N°1 Spool control cod. DO580550A58	
DO580550A58R10	Kit N°10 Posizionatori cod. DO580550A58 Kit N°10 Spool controls cod. DO580550A58	
DO580550B07R	N° 1 Posizionatore cod. DO580550B07 N° 1 Spool control cod. DO580550B07	
DO580550B07R10	Kit N°10 Posizionatori cod. DO580550B07 Kit N°10 Spool controls cod. DO580550B07	
DO580550C08R	N° 1 Posizionatore cod. DO580550C08 N° 1 Spool controls cod. DO580550C08	
DO580550C08R10	Kit N°10 Posizionatori cod. DO580550C08 Kit N°10 Spool controls cod. DO580550C08	

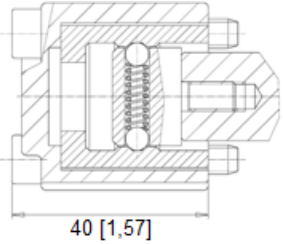
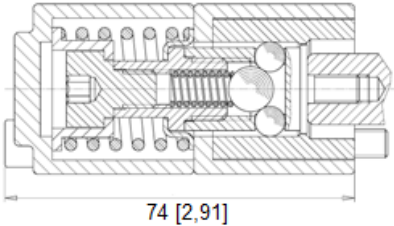

DO580550D01R	N° 1 Posizionatore cod. DO580550D01 N° 1 Spool control cod. DO580550D01	
DO580550D01R10	Kit N°10 Posizionatori cod. DO580550D01 Kit N°10 Spool controls cod. DO580550D01	
DO580550N14R	N°1 Posizionatore cod. DO580550N14 N°1 Spool control cod. DO580550N14	
DO580550N14R10	Kit N°10 Posizionatori cod. DO580550N14 Kit N°10 Spool controls cod. DO580550N14	

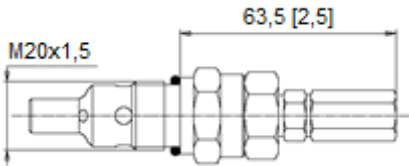
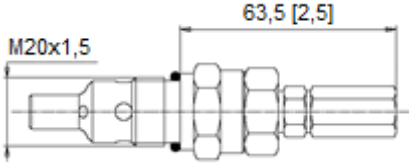
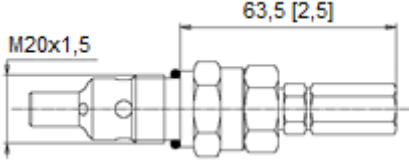
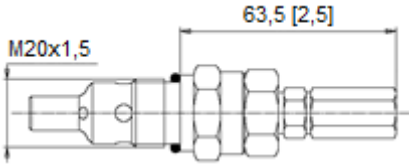
DOWPD02M20080R	h 24	N° 1 Cartuccia VMP dir. A grano X 80 bar N° 1 Dir. Cartridge VMP grain X 80 bar	
DOWPD02M20080R05	h 24	Kit N°5 Cartucce VMP dir. A grano X 80 bar Kit N°5 Dir. Cartridge VMP grain X 80 bar	
DOWPD02M20130R	h 24	N° 1 Cartuccia VMP dir. A grano Y 130 bar N° 1 Dir. Cartridges VMP grain Y 130 bar	
DOWPD02M20130R05	h 24	Kit N°5 Cartucce VMP dir. A grano Y 130 bar Kit N°5 Dir. Cartridges VMP grain Y 130 bar	
DOWPD02M20180R	h 24	N°1 Cartuccia VMP dir. A grano Z 180 bar N°1 Dir. Cartridge VMP grain Z 180 bar	
DOWPD02M20180R05	h 24	Kit N° 5 Cartucce VMP dir. A grano Z 180 bar Kit N° 5 Dir. Cartridges VMP grain Z 180 bar	
DOWPD02M20210AP R	h 24	N° 1 Cartuccia VMP dir. A grano K 210 bar N° 1 Dir. Cartridge VMP grain K 210 bar	
DOWPD02M20210AP R05	h 24	Kit N°5 Cartucce VMP dir. A grano K 210 bar Kit N°5 Dir. Cartridges VMP grain K 210 bar	



DOWLP02M14080R	N°1 Cartuccia VL ML con OR tar. 80 bar <i>N° 1 Cartridge VL ML with OR set. 80 bar</i>	
DOWLP02M14080R10	Kit N°10 Cartucce VL ML con OR tar. 80 bar <i>Kit N°10 Cartridges VL ML with OR set. 80 bar</i>	
DOWLP02M14130R	N° 1 Cartuccia VL ML con OR tar. 130 bar <i>N° 1 Cartridge VL ML with OR set. 130 bar</i>	
DOWLP02M14130R10	Kit N°10 Cartucce VL ML con OR tar. 130 bar <i>Kit N°10 Cartridges VL ML with OR set. 130 bar</i>	
DOWLP02M14180R	N° 1 Cartuccia VL ML con OR tar. 180 bar <i>N° 1 Cartridge VL ML with OR set. 180 bar</i>	
DOWLP02M14180R10	Kit N°10 Cartucce VL ML con OR tar. 180 bar <i>Kit N°10 Cartridges VL ML with OR set. 180 bar</i>	
DOWLP02M14210R	N° 1 Cartuccia VL ML con OR tar. 210 bar <i>N° 1 Cartridge VL ML with OR set. 210 bar</i>	
DOWLP02M14210R10	Kit N°10 Cartucce VL ML con OR tar. 210 bar <i>Kit N°10 Cartridges VL ML with OR set. 210 bar</i>	

DO56102R	N°1 Micro cod. DO56102	
DO56102R10	Kit N°10 Micro cod. DO56102	
DO56107R	N°1 Micro sing. Sez. Cod. DO56107 <i>N°1 Micro single sect. Cod. DO56107</i>	
DO56107R10	Kit N°10 Micro sing. Sez. Cod. DO56107 <i>Kit N°10 Micro single sect. Cod. DO56107</i>	

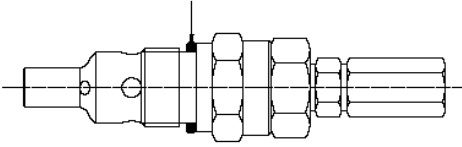
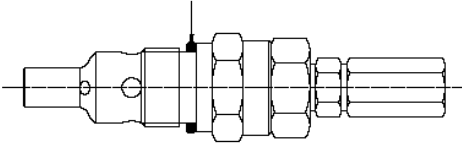
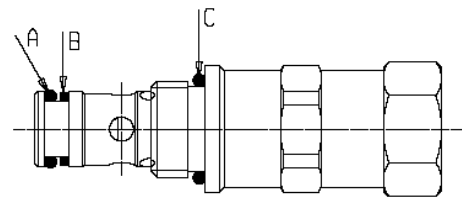
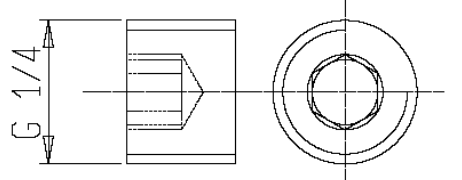
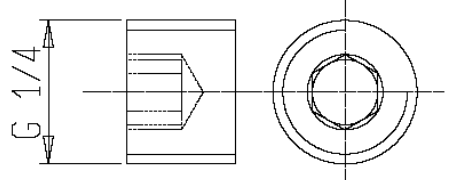
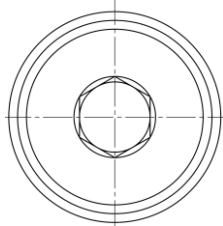

DO526A05NN001R50	h 24	Kit N°50 OR cod. DO350B17086NBR90 per VMP Kit N°50 OR cod. DO350B17086NBR90 for VMP	
DO526B05NN001R50	h 24	Kit N°50 BR cod. DO315617 per VMP Kit N°50 BR cod. DO315617 for VMP	
DO526C060E001R50	h 24	Kit N°50 OR cod. DO350A07065NBR70 (rif.A) + N°50 BR cod. DO3188011 (rif.B) + N°50 OR cod. DO350A12042NBR90 (rif.C) per VL per ML Kit N°50 OR cod. DO350A07065NBR70 (ref.A) + N°50 BR cod. DO3188011 (ref.B) + N°50 OR cod. DO350A12042NBR90 (ref.C) for VL for ML	
DO3403001401R	h 24	N°1 Kit C.O. DO3403001401 N°1 C.O. kit DO3403001401	
DO3403001401R10	h 24	Kit N°10 Kit C.O. DO3403001401 Kit N°10 C.O. kit DO3403001401	
DO587203801R50		Kit N°50 tappi 3/8G cod. DO587203801 Kit N°50 plugs 3/8G cod. DO587203801	
DO587218001R50		Kit N°50 tappi M18x1,5 cod. DO587218001 Kit N°50 plugs M18x1,5 cod. DO587218001	
DO587S34001R50		Kit N°50 tappi 3/4-SAE cod. DO587S34001 Kit N°50 plugs 3/4-SAE cod. DO587S34001	
DO526A02NN001R50	h 24	Kit N°50 OR cod. DO350B15008NBR60 per spole d. 15 mm Kit N°50 OR cod. DO350B15008NBR60 for d. 15 mm spools	/