

Technical features

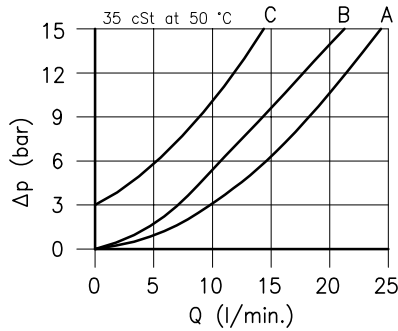
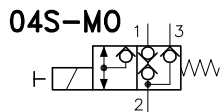
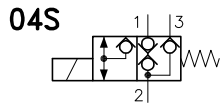
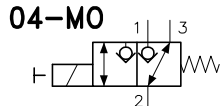
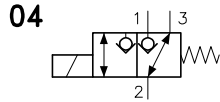

A = 2 ↔ 1 (3204)
 B = 2 → 3 (3204) 2 ↔ 1 (3204S)
 C = 3 → 2 (Q max. 15 l/min.)

Cavity	(For dimensions see catalogue 17.000)	S 30/3
Max. flow	3204/3204-MO (l/min.)	25
Max. flow	3204S/3204S-MO (l/min.)	20
Max. pressure	(bar)	315
Response time	(ms)	30 - 60
It change in function of circuit, pressure, flow and fluid viscosity.		(Mean value)
Fluid viscosity range	(cSt)	2.8 - 380
Fluid temperature range	(°C)	-20 +80
Mass	(kg)	0.240
Hydraulic fluid; mineral oil HM and HV ISO 6074		
Recommended filtration; 19/15 ISO 4466 (25 μ absolutes)		
Standard seals in Polyurethane and Buna N		

Dimensions

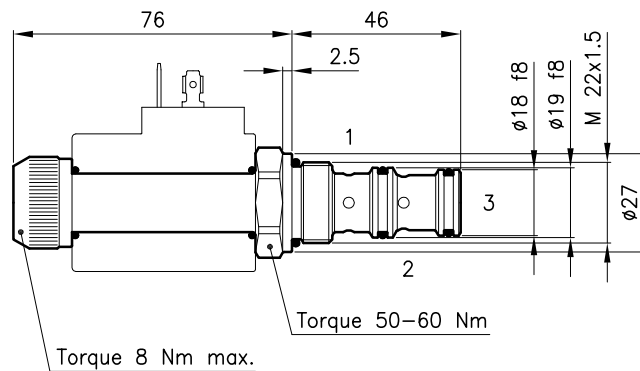
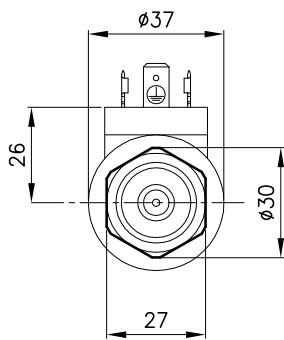

Ordering informations

ECD 30/3204-MO

ECD 30/32.. = Valve type

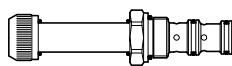

Circuits

3204

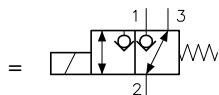

3204S

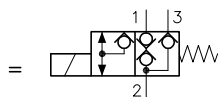

MO = Manual override
(Omit if not request)

Codes:

ECD 30/3204	35 011 126
ECD 30/3204-MO	35 011 127
ECD 30/3204S	35 011 148
ECD 30/3204S-MO	35 011 147
External seals kit	90 620 104

ECD 30/32.. valves can be assembled on standard bodies 30-C3 series; for dimensions see catalogue 16.010

On the ECD 30 valves must be assembled the Coils B30 series; for dimensions, features and codes see catalogues 09.900 and 09.901.