

YB 150

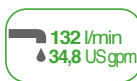

POMPE A PISTONI AD ALTA PRESSIONE
HIGH PRESSURE PISTON PUMPS
POMPES A PISTONS A HAUTE PRESSION
BOMBAS CON PISTONES DE ALTA PRESION
HOCHDRUCK-KOLBENPUMPEN

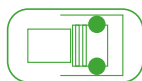

Configurazione: 6 pistoni striscianti con cilindro in ceramica. Parti a contatto con il liquido: alluminio anodizzato con trattamento cataforesi. A richiesta: protezione p.d.f. Doppia guarnizione con recupero del gocciolamento. Sistema brevettato anti-usura dei paraolio pistoni. Aspirazione con unico raccordo.

Configuration: 6 sliding pistons and ceramic cylinder. Parts in contact with spray liquid: anodized aluminium and cathaphoresis treatment. On request: PTO protection. Double seal with drip recovery. Patented piston oil guard anti-wear system. Single-connection suction.

Configuration: 6 pistons coulissants avec cylindre en céramique. Parties au contact du liquide: aluminium anodisé avec traitement de cataphorèse. À la demande: protection prise de force. Joint double avec récupération de l'égouttement. Système breveté anti-usure des joints à lèvre des pistons. Aspiration à un seul raccord.

Configuración: 3 pistones deslizantes con cilindro de cerámica. Partes en contacto con el líquido: aluminio anodizado con tratamiento de cataforesis. Bajo pedido: protección t.d.f.. Junta doble con recuperación del goteo. Sistema patentado anti-desgaste de los sellos de aceite de los pistones.

Konfigurierung: 6 Gleitkolben mit Zylinder aus Keramik. Teile im Kontakt mit der Flüssigkeit: eloxiertes Aluminium mit Kataphoresebehandlung. Auf Wunsch: Zapfwellenschutz. Doppeldichtung mit Rückgewinnung des Tropfens. Patentiertes Verschleißschutzsystem der Ölspritzringe. Ansaugung mit einem einzigen Anschluss.

- * Trattamento cataforesi.
- * Cathaphoresis treatment.
- * Traitement de cataphorèse.
- * Tratamiento de cataforesis.
- * Kataphoresebehandlung.

YB 150

		0 bar - 0 p.s.i		20 bar - 290 p.s.i		30 bar - 435 p.s.i		40 bar - 580 p.s.i			
RPM	l/min U.S.g.p.m.	HP kW	HP kW	HP kW	HP kW	HP kW	HP kW	HP kW	HP kW	kg	lb
400	88 23,2	0,8 0,6	5,1 3,8	7,1 5,2	9,1 6,7	30	66,1				
450	99 26,1	0,9 0,6	5,7 4,2	8,0 5,9	10,3 7,6						
500	110 29,0	1,0 0,7	6,4 4,7	8,9 6,5	11,4 8,4						
550	121 31,9	1,0 0,7	7,1 5,2	9,8 7,2	12,7 9,4						
600	132 34,8	0,9 0,7	7,9 5,8	10,7 7,8	13,9 10,2						

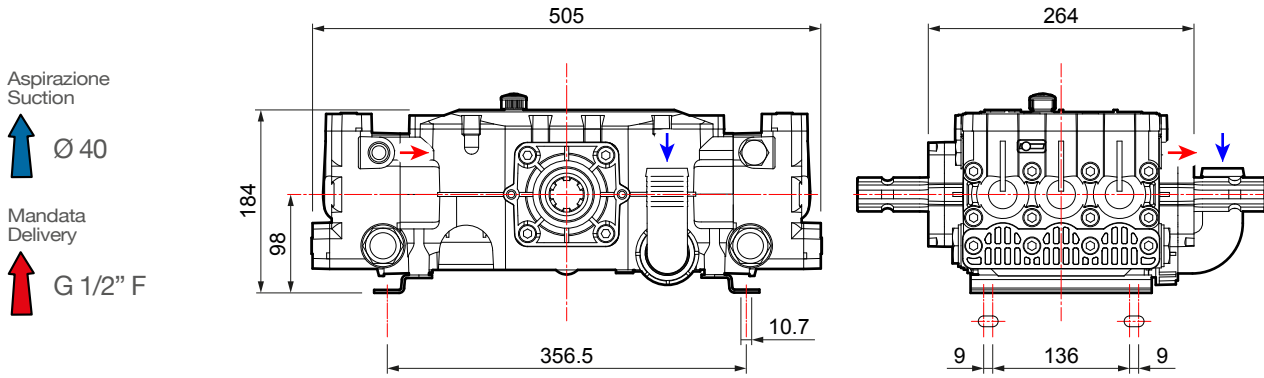

VERSIONI STANDARD · STANDARD VERSIONS · VERSIONS STANDARD · VERSIONES ESTÁNDAR · STANDARDAUSFÜHRUNGEN

Versioni derivate · Versions adapted · Versions dérivées · Versiones derivadas · Von der Standardversion abgeleitete Ausführungen

A



Albero passante
Through shaft
Arbre traversant
Cigüeñal pasante
Durchgangswelle

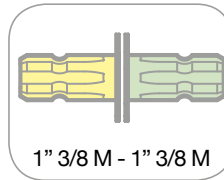

1" 3/8 M - 1" 3/8 M

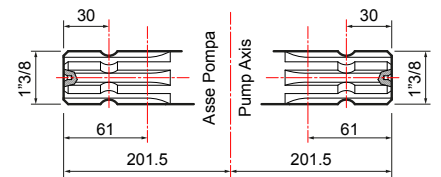

B



Albero passante
Through shaft
Arbre traversant
Cigüeñal pasante
Durchgangswelle

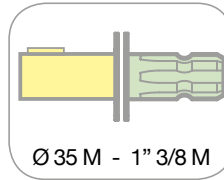

Ø 35 M - 1" 3/8 M

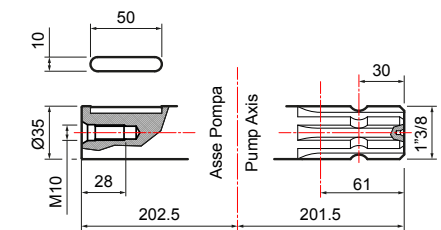

1



Kit Puleggia
Pulley kit
Kit Poulie
Kit Polea
Riemenscheibenkit

