

Technical features

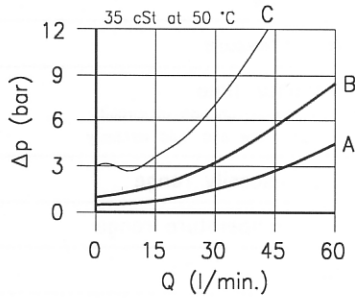
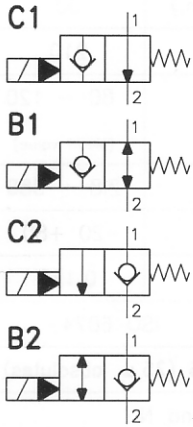

	22C1	22B1	22C2	22B2
1 → 2 De-en.	curve A	curve A	not allowed	not allowed
2 → 1 De-en.	not allowed	curve A	curve B	curve B
1 → 2 Energ.	not allowed	not allowed	curve A	curve A
2 → 1 Energ.	curve C	curve C	not allowed	curve A

Cavity (For dimensions see catalogue 17.000)	S 30/2
Max. flow (l/min.)	50
Max. pressure (bar)	210
Response time (ms) <small>It change in function of circuits pressure, flow and fluid viscosity.</small>	80 - 120 (Mean value)
Fluid viscosity range (cSt)	2.8 - 380
Fluid temperature range (°C)	-20 +80
Mass (kg)	0.160
Hydraulic fluid; mineral oil HM and HV ISO 6074	
Recommended filtration; 19/15 ISO 4466 (25 μ absolut)	
Standard seals in Polyurethane and Buna N	

Dimensions

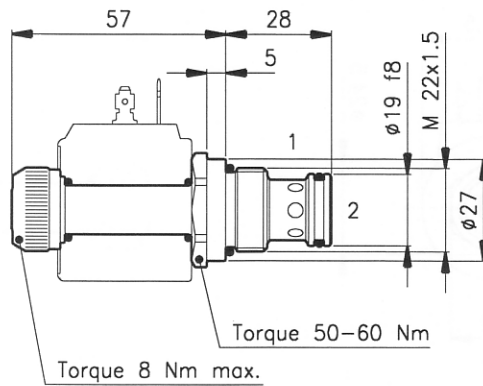
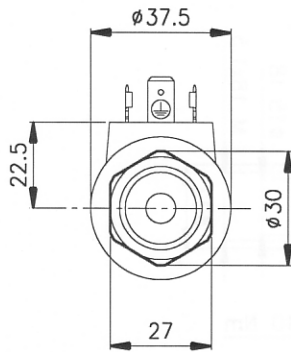

Ordering informations

ECP 30/22C1

ECP 30/22.. = Valve type

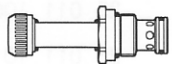

Circuits

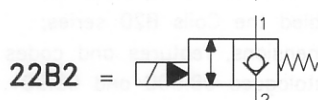
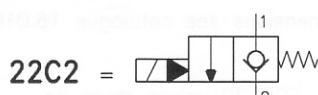
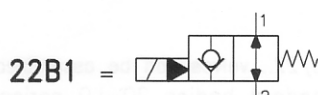
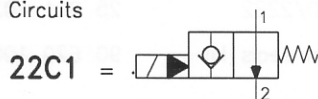

Codes:

ECP 30/22C1	35 011 112
ECP 30/22B1	35 011 111
ECP 30/22C2	35 011 102
ECP 30/22B2	35 011 101
External seals kit	90 620 103

ECP 30/22.. valves can be assembled on standard bodies 30-L0 series; for dimensions see catalogue 16.010

On the ECP 30 valves must be assembled the Coils B20 series; for dimensions, features and codes see catalogues 09.900 and 09.901.