



Catalogo generale ricambi

General spare parts catalogue

Catalogue générale des pièces de rechange

Ersatzteile-katalog

Catálogo de piezas



Battioni®
Pagani

Setting the pace since 1953

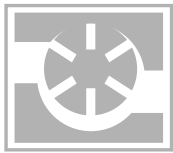

Battioni®
Pagani

MEC 2000-3000-4000 / M

Rel. 0 del 15.01.2018

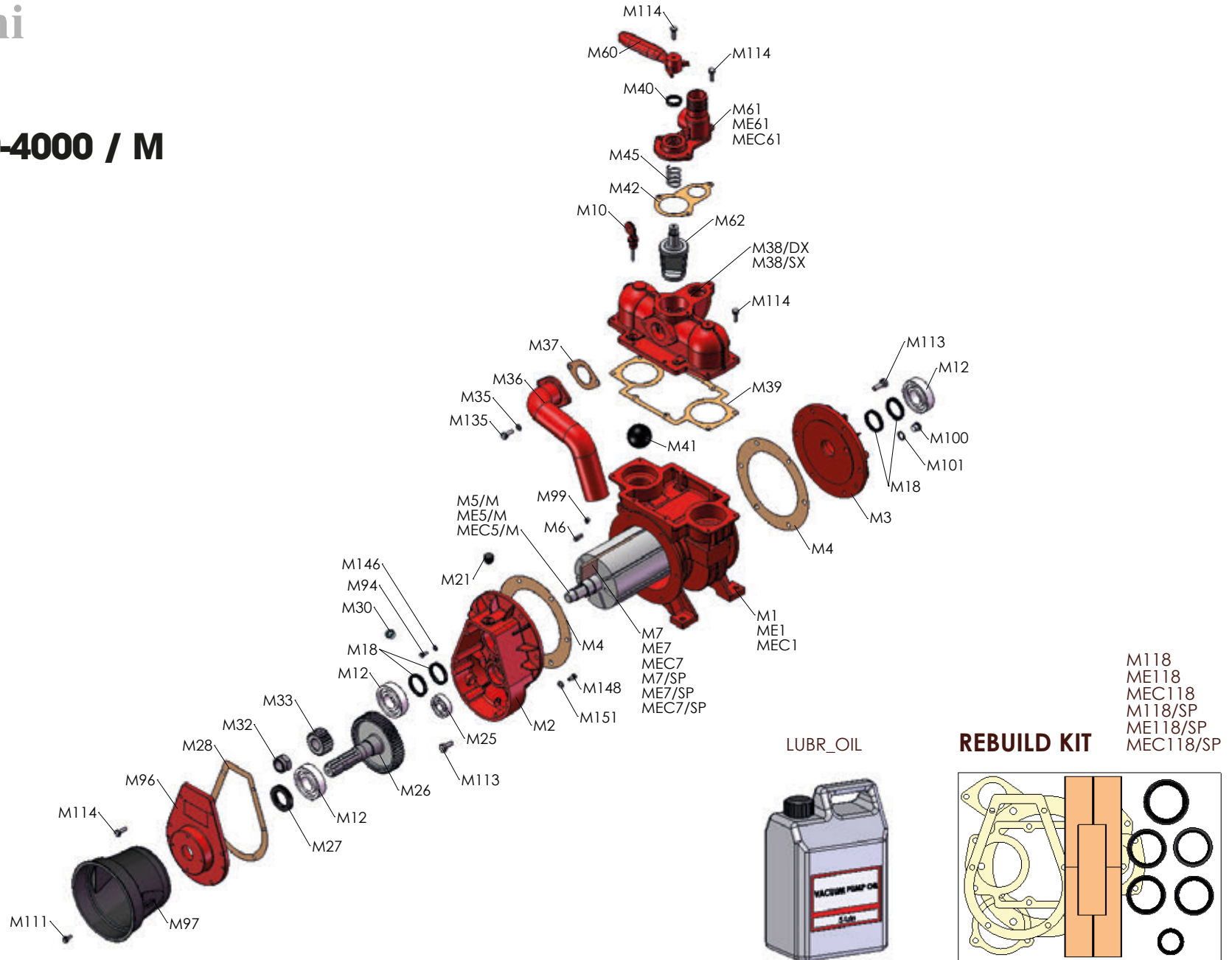

M118
ME118
MEC118
M118/SP
ME118/SP
MEC118/SP

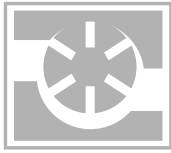

Battioni®
Pagani

MEC 2000-3000-4000 / P

Rel. 0 del 15.01.2018

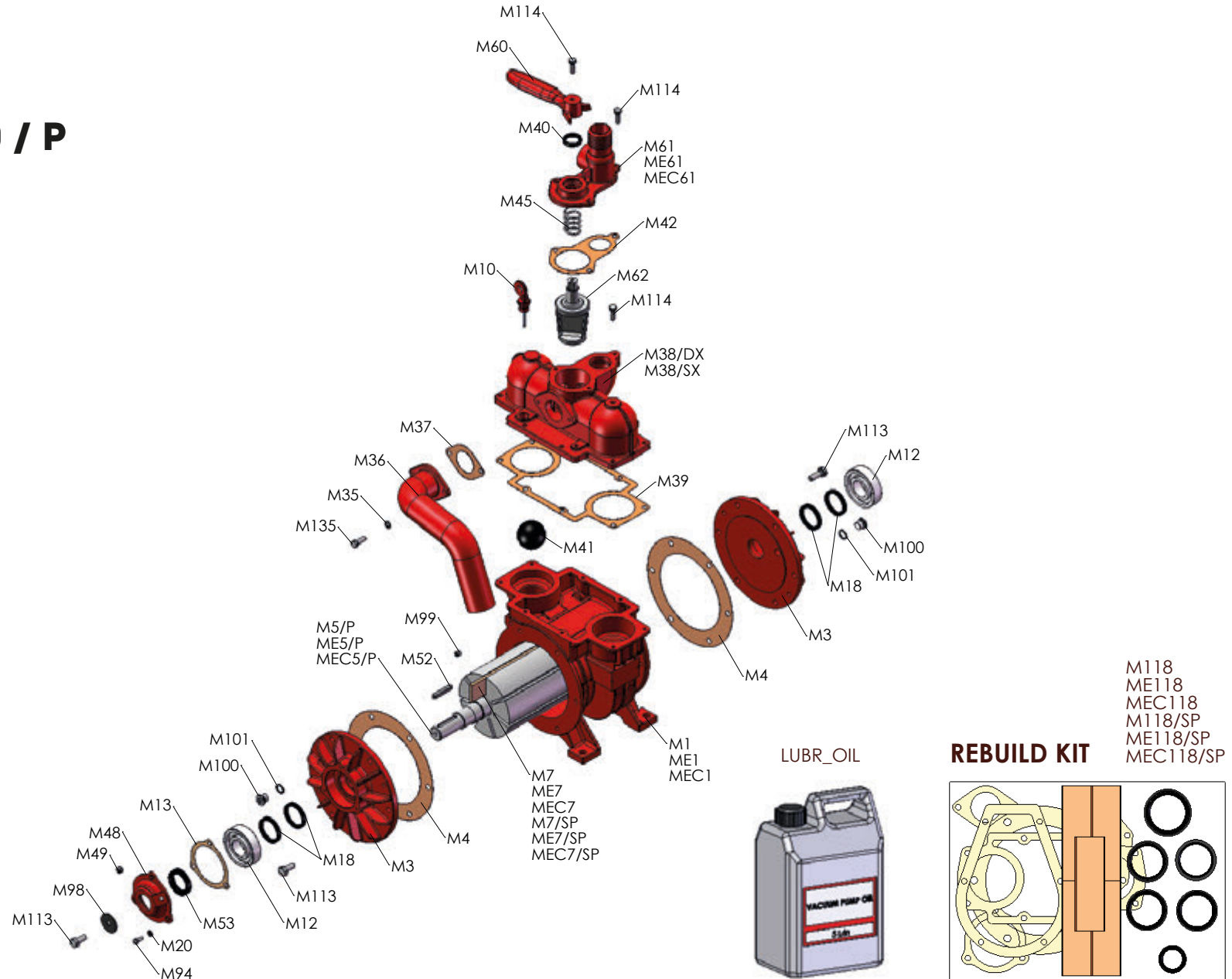

- M118
- ME118
- MEC118
- M118/SP
- ME118/SP
- MEC118/SP



**Battioni®
Pagani**

MEC 2000-3000-4000 / D

Rel. 0 del 15.01.2018

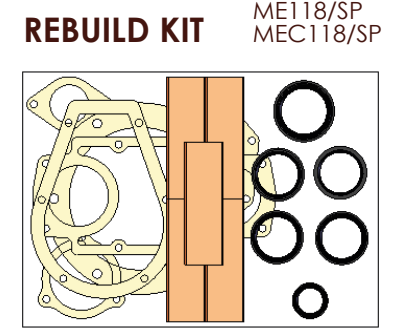
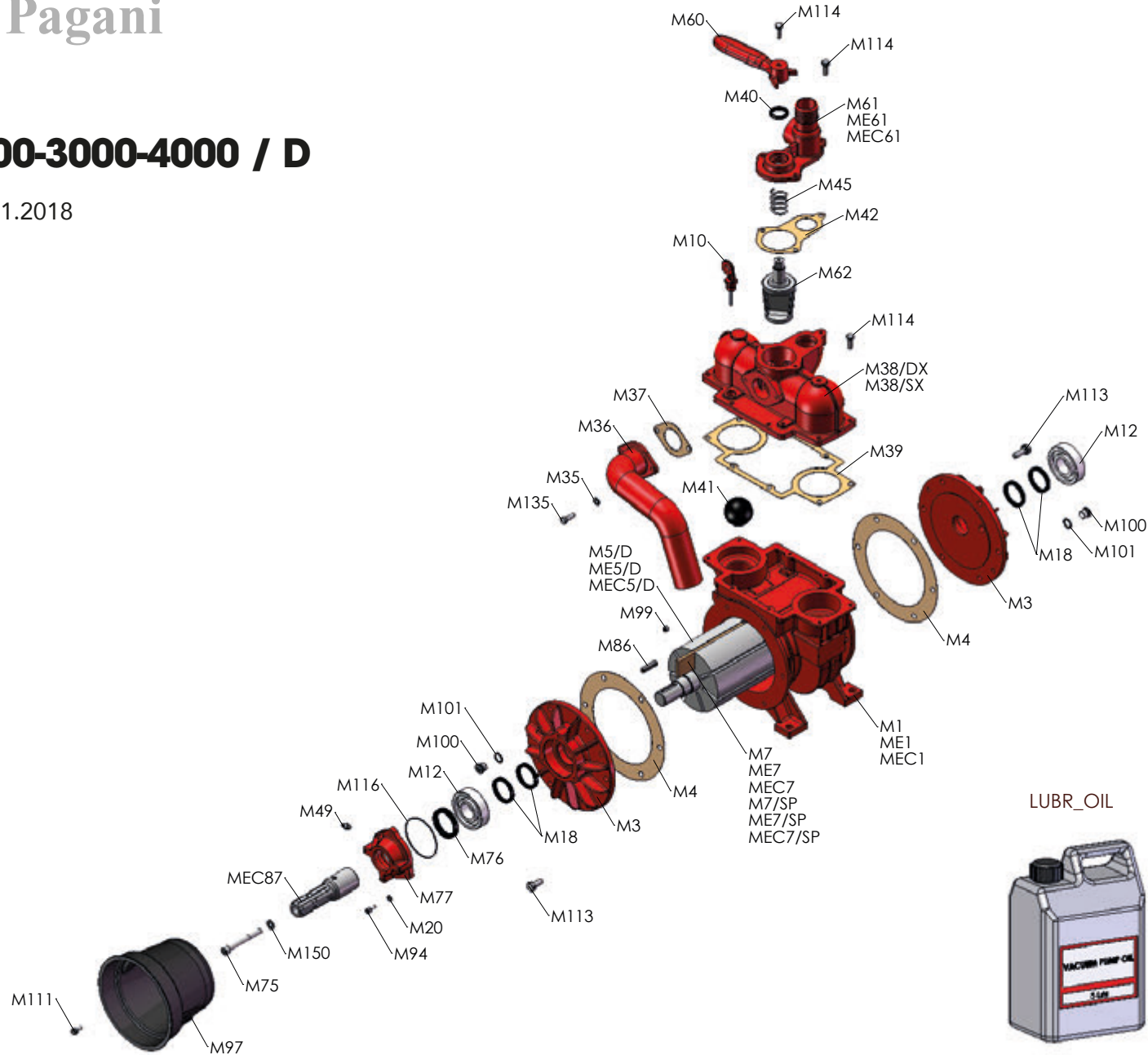

- M118
- ME118
- MEC118
- M118/SP
- ME118/SP
- MEC118/SP



Battioni®
Pagani

MEC 2000-3000-4000 / H

Rel. 0 del 15.01.2018

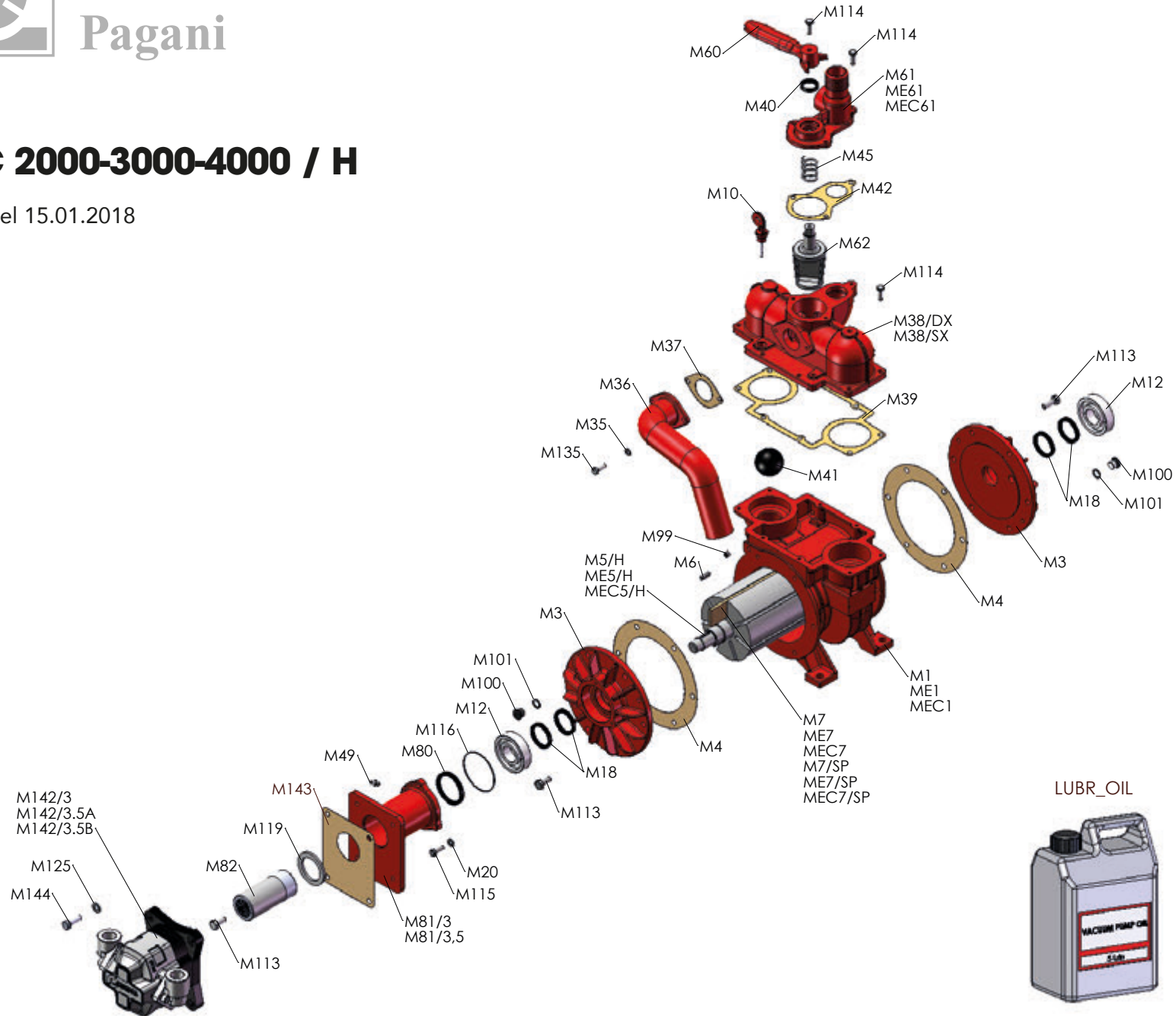

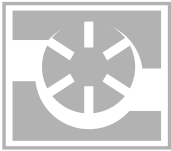

**Battioni®
Pagani**

MEC 2000/3000/4000

MEC 2000-3000-4000 / HM

Rel. 0 del 15.01.2018

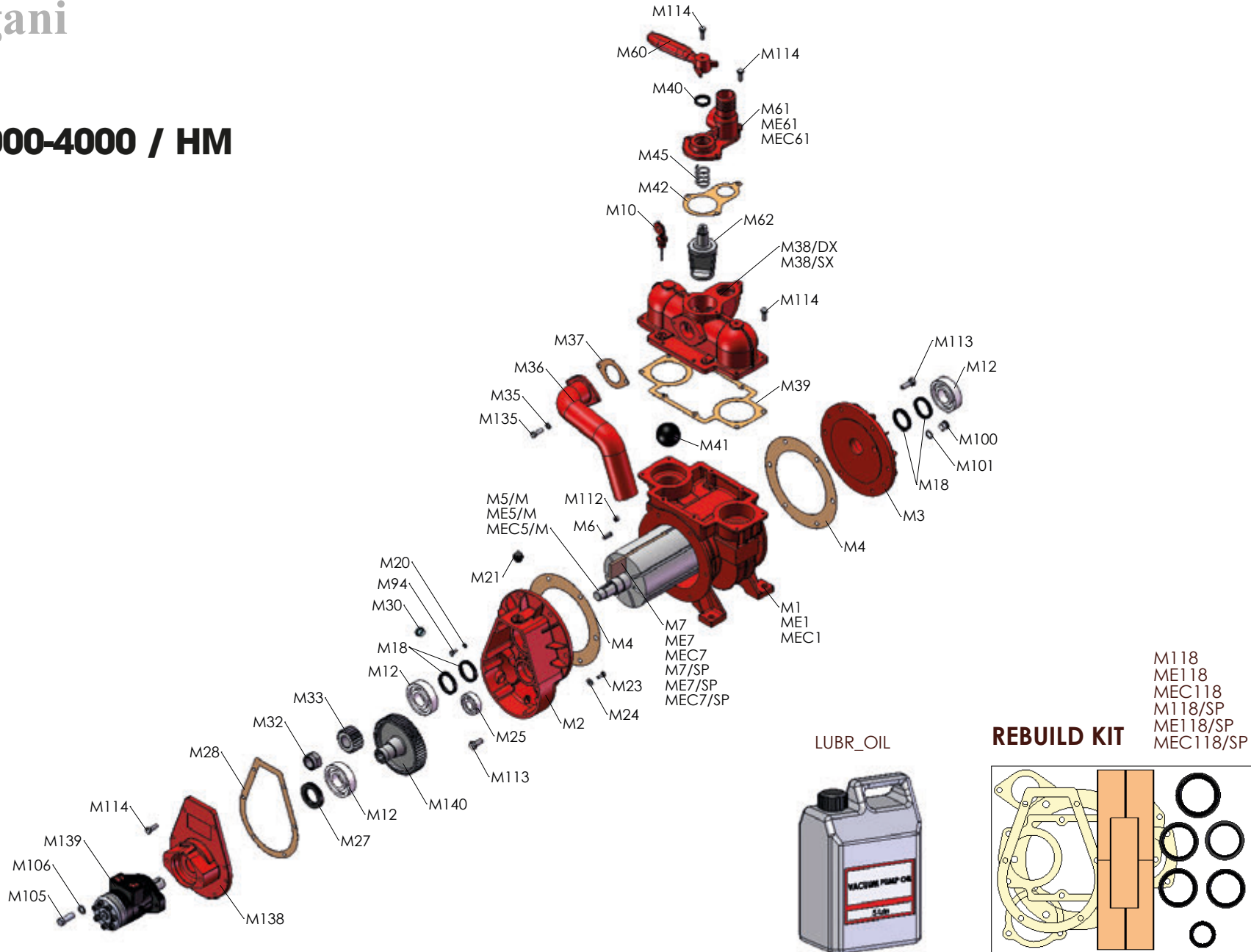

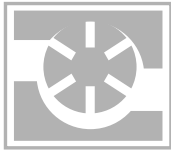

**Battioni®
Pagani**

MEC 2000-3000-4000 / G

Rel. 0 del 15.01.2018

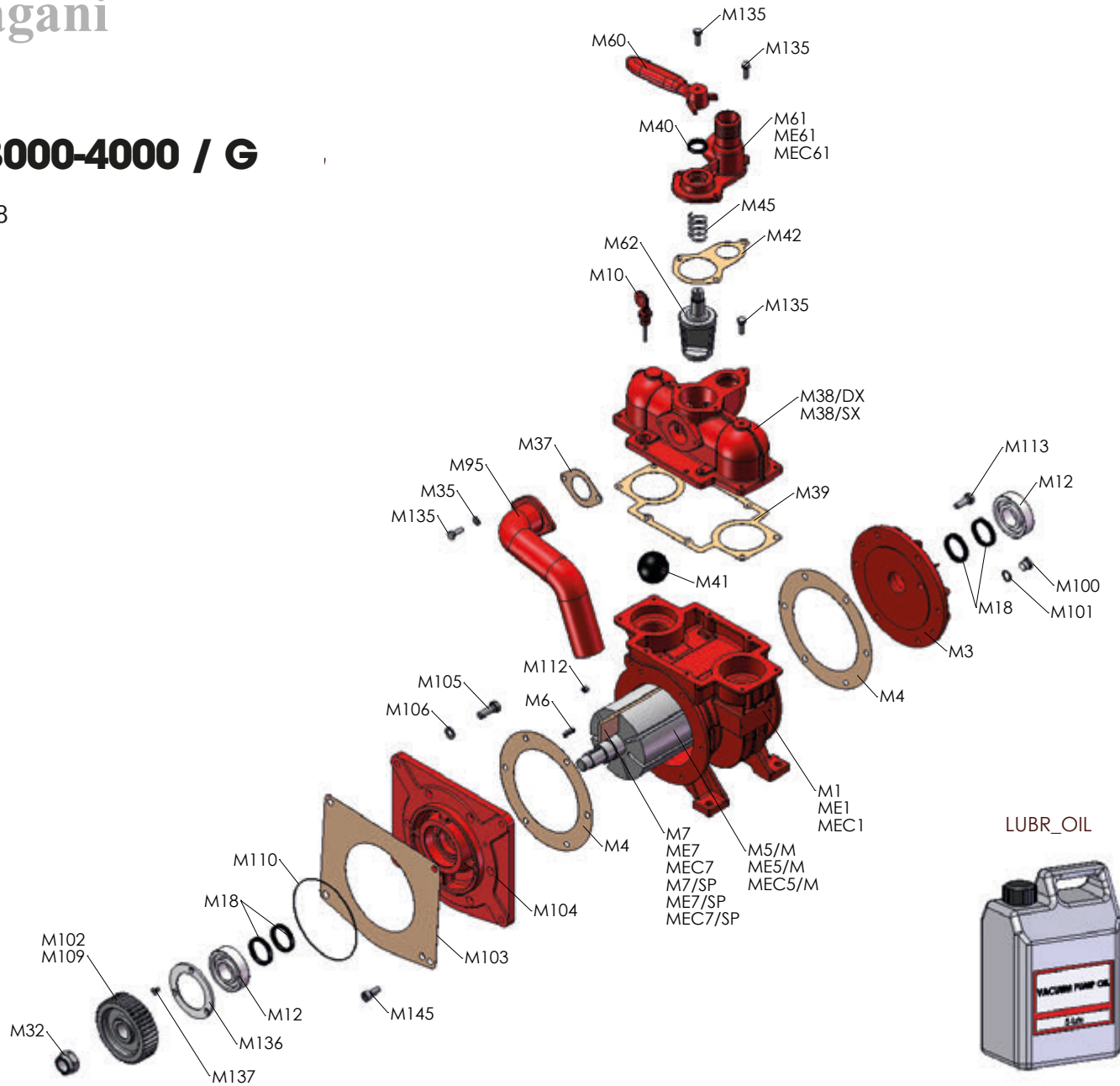

- M118
- ME118
- MEC118
- M118/SP
- ME118/SP
- MEC118/SP

LUBR_OIL



REBUILD KIT

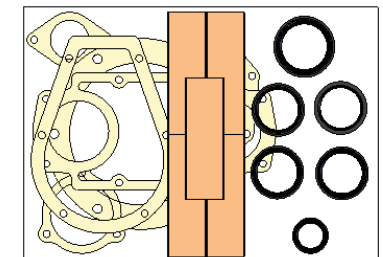



Battioni®
Pagani

MEC 2000-3000-4000 / U.L.

Rel. 0 del 15.01.2018

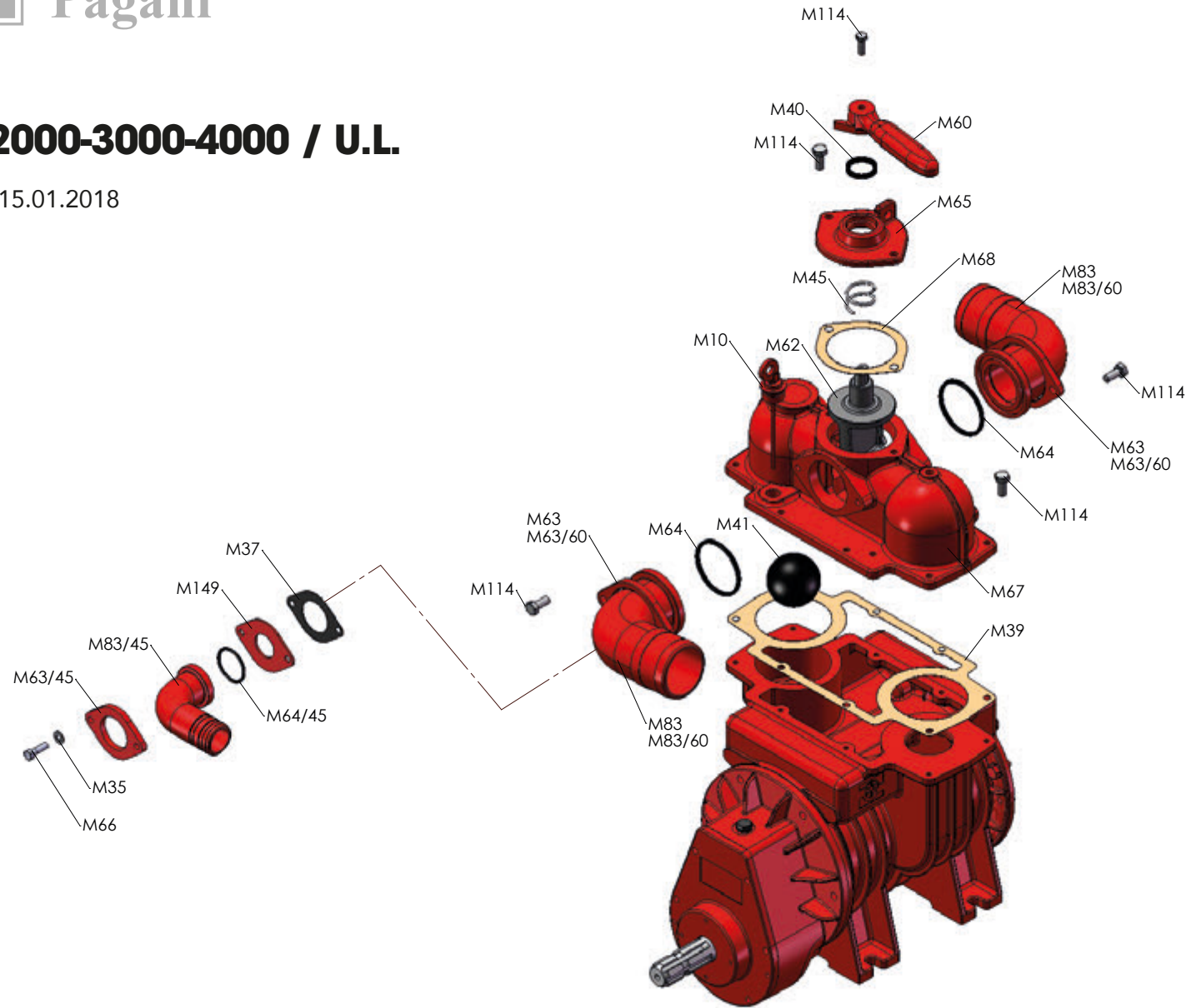

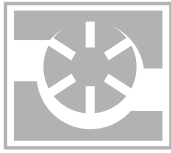

MEC 2000-3000-4000 / D.U.

Rel. 0 del 15.01.2018

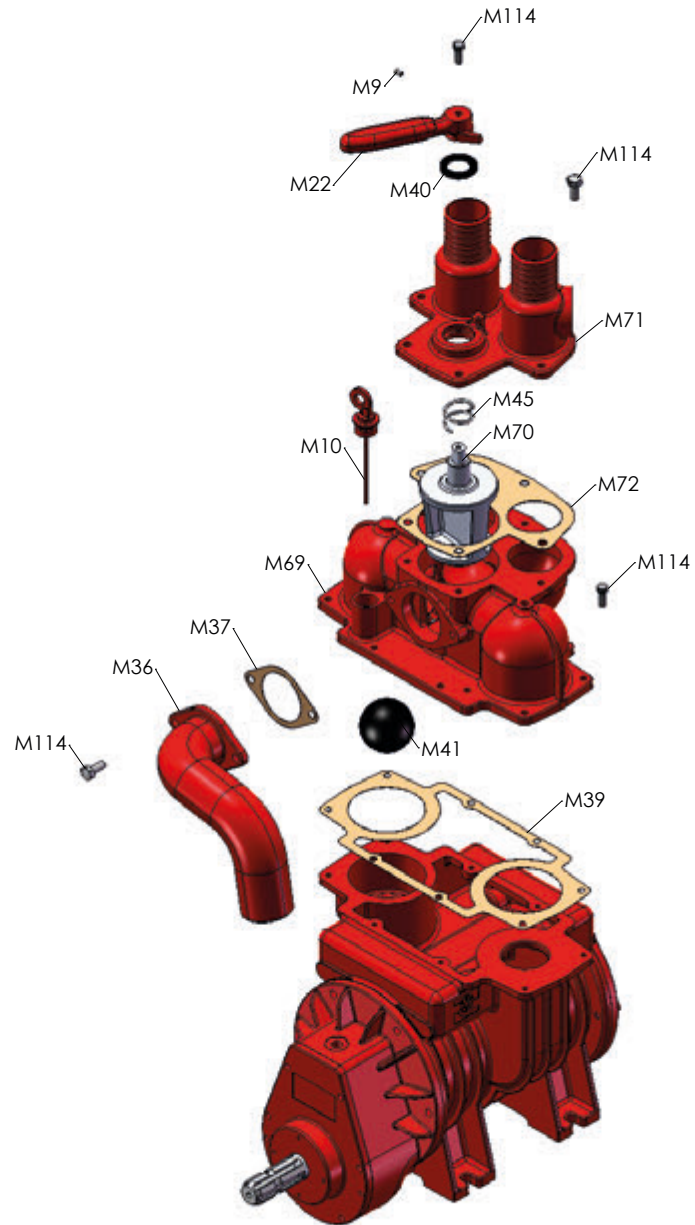



MEC 2000 - 3000 - 4000

<i>Articolo</i> (Article)	<i>Codice</i> (Code)	<i>Descrizione</i>	<i>(Description)</i>	<i>Q.ty</i>	<i>Um</i>
M1	4010101003	CORPO POMPA MEC 2000	HOUSING - MEC 2000	1	n
ME1	4010101004	CORPO POMPA MEC 3000	HOUSING - MEC 3000	1	n
MEC1	4010101005	CORPO POMPA MEC 4000	HOUSING - MEC 4000	1	n
M2	4010301002	SCATOLA MOLT. MEC 2-3-4000/M	GEARBOX - MEC 2-3-4000/M	1	n
M3	4010401002	FLANGIA ANT. POST. MEC 2000-3000-4000	FRONT AND BACK FLANGE - MEC 2-3000-4000	1	n
M4	4030108004	GUARN. FLANGIA MEC 2-4000	FLANGE GASKET - MEC 2-4000	2	n
M5/M	4010220005	ROTORE MEC 2000/M	ROTOR - MEC 2000/M	1	n
ME5/M	4010220006	ROTORE MEC 3000/M	ROTOR - MEC 3000/M	1	n
MEC5/M	4010220007	ROTORE MEC 4000/M	ROTOR - MEC 4000/M	1	n
M5/P	4010220008	ROTORE MEC 2000/P	ROTOR - MEC 2000/P	1	n
ME5/P	4010220009	ROTORE MEC 3000/P	ROTOR - MEC 3000/P	1	n
MEC5/P	4010220010	ROTORE MEC 4000/P	ROTOR - MEC 4000/P	1	n
M5/D	4010220068	ROTORE MEC 2000/D	ROTOR - MEC 2000/D	1	n
ME5/D	4010220069	ROTORE MEC 3000/D	ROTOR - MEC 3000/D	1	n
MEC5/D	4010220070	ROTORE MEC 4000/D	ROTOR - MEC 4000/D	1	n
M5/H	4010220078	ROTORE MEC 2000/H	ROTOR - MEC 2000/H	1	n
ME5/H	4010220079	ROTORE MEC 3000/H	ROTOR - MEC 3000/H	1	n
MEC5/H	4010220080	ROTORE MEC 4000/H	ROTOR - MEC 4000/H	1	n
M6	5050707002	CHIAVETTA 6X6X25	KEY - 6X6X25	1	n
M7	4070113003	PALETTA STANDARD MEC 2000 180X41X6.5	STANDARD BLADE - MEC 2000 180X41X6.5	7	n



MEC 2000 - 3000 - 4000

<i>Articolo</i> (Article)	<i>Codice</i> (Code)	<i>Descrizione</i>	<i>(Description)</i>	<i>Q.ty</i>	<i>Um</i>
ME7	4070113004	PALETTA STANDARD MEC 3000 240X41X6.5	STANDARD BLADE - MEC 3000 240X41X6.5	7	n
MEC7	4070113005	PALETTA STANDARD MEC 4000 300X41X6.5	STANDARD BLADE - MEC 4000 300X41X6.5	7	n
M7/SP	4070113120	PALETTA LONG LIFE MEC 2000 180X41X6.5	LONG LIFE BLADE - MEC 2000 180X41X6.5	7	n
ME7/SP	4070113121	PALETTA LONG LIFE MEC 3000 240X41X6.5	LONG LIFE BLADE - MEC 3000 240X41X6.5	7	n
MEC7/SP	4070113122	PALETTA LONG LIFE MEC 4000 300X41X6.5	LONG LIFE BLADE - MEC 4000 300X41X6.5	7	n
M10	5060100001	ASTA LIVELLO OLIO 18X55 MM	OIL LEVEL ROD - MM 18X55	1	n
M12	5012107010	CUSCINETTO A SFERE 6307	BALL BEARING - 6307	2	n
M18	5030300004	PARAOLIO 40X52X7	OIL SEAL - 40X52X7	4	n
M20	5050207002	RONDELLA D 6	SMOOTH WASHER - D 6	3	n
M21	5060605001	TAPPO CARICO OLIO D 3/8" GAS	OIL PLUG - D 3/8" GAS	1	n
M22	4010801001	MANIGLIA MEC 1-1600	HANDLE - MEC 1-1600	1	n
M25	5012107006	CUSCINETTO A SFERE 6304	BALL BEARING - 6304	1	n
M26	4020507002	INGR. CON ALBERO MEC 2-5000 Z55-M2,5	GEAR WITH SHAFT - Z55-M2,5 MEC 2-5000	1	n
M27	5030300005	PARAOLIO 35X62X10	OIL SEAL - 35X62X10	1	n
M28	4030108006	GUARN. COPERCHIO SCAT. MOLT. MEC 2-8000	GEARBOX COVER GASKET - MEC 2-8000	1	n
M30	5060105004	TAPPO LIVELLO OLIO D 3/8" GAS	OIL LEVEL PLUG - D 3/8" GAS	1	n
M32	5050300001	DADO AUTOBLOCCANTE M 24X2X15	SELF-LOCKING NUT - M 24X2X15	1	n
M33	4020607002	PIGNONE MEC 2-5000 Z21-M2,5	PINION - Z21-M2,5 MEC 2-5000	1	n
M35	5050207003	RONDELLA D 8	SMOOTH WASHER - D 8	2	n
M36	4010901002	CURVA DI SCARICO MEC 2-4000	EXHAUST ELBOW - MEC 2-4000	1	n
M37	4030110002	GUARN. LATERALE COLL. MEC 2-4000	MANIFOLD SIDE GASKET - MEC 2-4000	1	n



MEC 2000 - 3000 - 4000

<i>Articolo</i> (Article)	<i>Codice</i> (Code)	<i>Descrizione</i>	<i>(Description)</i>	<i>Q.ty</i>	<i>Um</i>
M38/DX	4010501002	COLLETTORE MEC 2-4000	MANIFOLD - MEC 2-4000	1	n
M38/SX	4010501024	COLLETTORE MEC 2-4000 SINISTRO	MANIFOLD - MEC 2000-4000 CCW	1	n
M39	4030109003	GUARN. COLLETTORE MEC 2-4000	MANIFOLD GASKET - MEC 2-4000	1	n
M40	5030300003	PARAOLIO 25X35X7 TC	OIL SEAL - 25X35X7 TC	1	n
M41	5060410005	SFERA IN GOMMA PESANTE 55	RUBBER BALL - D 55	1	n
M42	4030109004	GUARN. COPERCHIO COLL. MEC 2-4000	MANIFOLD COVER GASKET - MEC 2-4000	1	n
M45	4012007001	MOLLA MEC 2-4000	SPRING - MEC 2-4000	1	n
M48	4010601012	COPERCHIO ANTERIORE MEC 2-3-4000/P	FRONT COVER - MEC 2-3-4000/P	1	n
M49	5050812001	INGRASSATORE M 10X1	LUBRICATOR - M 10X1	1	n
M52	5050707007	CHIAVETTA 8X7X50	KEY - 8X7X50	1	n
M53	5030300002	PARAOLIO 35X52X10	OIL SEAL - 35X52X10	1	n
M60	4010801007	MANIGLIA MEC 2-8000	HANDLE - MEC 2-8000	1	n
M61	4010601010	COPERCHIO COLLETTORE D 45 MEC 2000	MANIFOLD COVER - MEC 2000 D45	1	n
ME61	4010601011	COPERCHIO COLLETTORE D 60 MEC 3-4000	MANIFOLD COVER - MEC 3-4000 D60	1	n
MEC61	4010601073	COPERCHIO COLLETTORE D 76 MEC 3-4000	MANIFOLD COVER - MEC 3-4000 D76	1	n
M62	4010701002	CONO INVERTITORE MEC 2-4000	REVERSING GEAR - MEC 2-4000	1	n
M63	4010406014	FLANGIA PREMIGURVA D 51 - MEC 2000	FLANGE FOR ELBOW - MEC 2000 D51	2	n
M63/45	4010406036	FLANGIA PREMIGURVA D 45 - MEC 2000	FLANGE FOR ELBOW - MEC 2000 D45	2	n
M63/60	4010406025	FLANGIA PREMIGURVA D 60 - MEC 2000	FLANGE FOR ELBOW - MEC 2000 D60	2	n
M64	5030210035	ANELLO TENUTA OR 6225 MEC 2000 UL	SEAL RING - OR 6225 MEC 2000 UL	2	n
M64/45	5030210082	ANELLO TENUTA D 42.86X3.53 OR147	SEAL RING - OR147 D 42.86X3.53	2	n



MEC 2000 - 3000 - 4000

<i>Articolo</i> (Article)	<i>Codice</i> (Code)	<i>Descrizione</i>	<i>(Description)</i>	<i>Q.ty</i>	<i>Um</i>
M65	4010601107	COPERCHIO COLLETTORE MEC 2-4000 UL	MANIFOLD COVER - MEC 2-4000 UL	1	n
M66	5050107012	VITE M 8X30 TE	SCREW - M 8X30 TE	4	n
M67	4010501013	COLLETTORE MEC 2-4000 UL	MANIFOLD - MEC 2-4000 UL	1	n
M68	4030109029	GUARN. COPERCHIO COLL. MEC 2-4000 UL	MANIFOLD COVER GASKET - MEC 2-4000 UL	1	n
M69	4010501003	COLLETTORE MEC 2-4000 DU	MANIFOLD - MEC 2-4000 DU	1	n
M70	4010701003	CONO INVERTITORE MEC 2-4000 DU	REVERSING GEAR - MEC 2-4000 DU	1	n
M71	4010601013	COPERCHIO COLLETTORE MEC 2-4000 DU	MANIFOLD COVER - MEC 2-4000 DU	1	n
M72	4030109008	GUARN. COPERCHIO COLL. MEC 2-4000 DU	MANIFOLD COVER BASKET - MEC 2-4000 DU	1	n
M74	5050202002	RONDELLA D 10X16X1,5 ALLUMINIO	ALUMINIUM WASHER - D 10X16X1,5	1	n
M75	5050107050	VITE M 10X90 TCEI	SCREW M 10X90 TCEI	1	n
M76	5030300032	PARAOLIO 45X60X10	OIL SEAL - 45X60X10	1	n
M77	4010601101	COPERCHIO ANTERIORE CE MEC 2-8000/D	FRONT COVER - CE MEC 2-8000/D	1	n
M80	5030300013	PARAOLIO 55X68X8	OIL SEAL - 55X68X8	1	n
M81/3	4011001045	SUPPORTO MOTORE IDR. MEC 2-8000/H GR. 3	HYDR. MOT. SUPPORT - MEC 2-8000/H GR. 3	1	n
M81/3,5	4011001016	SUPPORTO MOTORE IDR.MEC 2-11000/H GR.3,5	HYDR. MOT. SUPPORT - MEC 2-11000/H GR.3,5	1	n
M82	4020107006	MANICOTTO TRASM. MOT. IDR. MEC 2-5000	HYDR. MOTOR TRANSM. COUPLING MEC 2-5000	1	n
M83	4010901016	CURVA DI SCARICO ORIENTAB.D51 MEC 2/4000	REVOLVING ELBOW - MEC 2-4000 D 51	2	n
M83/45	4010901021	CURVA DI SCARICO ORIENTAB.D45 MEC 2/4000	REVOLVING ELBOW - MEC 2-4000 D 45	2	n
M83/60	4010901021	CURVA DI SCARICO ORIENTAB.D60 MEC 2/4000	REVOLVING ELBOW - MEC 2-4000 D 60	2	n
M86	5050707015	CHIAVETTA 8X7X40	KEY - 8X7X40	1	n
MEC87	5020107001	PRESA CALETTATA FORO D 30 -Ø 1"3/8	SPLINED HUB HOLE D 30 -SLOT 8 - D 1"3/8	1	n



MEC 2000 - 3000 - 4000

<i>Articolo</i> (Article)	<i>Codice</i> (Code)	<i>Descrizione</i>	<i>(Description)</i>	<i>Q.ty</i>	<i>Um</i>
M94	5050107005	VITE M 6X16 TE	SCREW - M 6X16 TE	8	n
M95	4010901010	CURVA DI SCARICO MEC 2-4000/G	EXHAUST ELBOW - MEC 2-4000/G	1	n
M96	4010601115	COPERCHIO SCATOLA MOLT. MEC 2-8000 CE	GEARBOX COVER - MEC 2-8000 CE	1	n
M97	4060505000	PROTEZIONE ALBERO CE	SHAFT GUARD - CE	1	n
M98	5050207008	RONDELLA TRANCIATA D 10X40	BLANK WASHER - D 10X40	1	n
M99	5050903001	TAPPO M 10x1 - DIN 906	PLUG - M 10X1 - DIN 906	1	n
M100	5050906006	TAPPO D 16x1,5 - DIN 908 -	PLUG - D 16X1,5 - DIN 908	2	n
M101	5050202007	RONDELLA D 16X20X1,5 ALLUMINIO	ALUMINIUM WASHER - D 16X20X1,5	2	n
M102	4020607004	PIGNONE DEC. GARDA MEC 2-5000 G Z39-M3	GARDA PINION - Z39-M3 MEC 2-5000 G	1	n
M103	4030108029	GUARN. FLANGIA SUPP. DECOMPR. MEC /G	PUMP SUPPORT GASKET - MEC/G	1	n
M104	4010401006	FLANGIA SUPPORTO DEC. GARDA/2-3-4000	PUMP SUPPORT FLANGE - MEC/G 2-3-4000	1	n
M109	4020607016	PIGNONE DEC. GARDA MEC 2-5000 GA Z50-M3	GARDA PINION - Z50-M3 MEC 2-5000 GA	1	n
M110	5030210060	ANELLO DI TEN. SUPP. DEC. OR171.12x2.62	SEAL RING - OR171.12x2.62 .../G	1	n
M111	5050107107	VITE M 6x10 TEF - FL/ZIGR 8.8 -	GALVANIZED SCREW - M 6X10 TEF	4	n
M113	5050107109	VITE M 10X25 TEF - FL/ZIGR 8.8 -	SCREW - M 10X25 TEF - FL/ZIGR 8.8	13	n
M114	5050107108	VITE M 8X25 TEF - FL/ZIGR 8.8 -	SCREW - M 8X25 TEF - FL/ZIGR 8.8	20	n
M115	5050107122	VITE M 6X25 TE -10.9 -	SCREW - M 6X25 TE -10.9 -	3	n
M118	6010201003	KIT REVISIONE POMPA MEC 2000 STANDARD	REBUILD KIT - MEC 2000 STANDARD	1	n
M119	4011707041	ANELLO DI RIDUZ. PER MOT. IDR. G.3 MEC	CENTERING RING FOR HYDR. MOTOR - MEC GR3	1	n
M125	5050207004	RONDELLA D 10	SMOOTH WASHER - D 10	4	n
M135	5050107009	VITE M 8X20 TE	SCREW - M 8X20 TE	2	n



MEC 2000 - 3000 - 4000

<i>Articolo</i> (Article)	<i>Codice</i> (Code)	<i>Descrizione</i>	<i>(Description)</i>	<i>Q.ty</i>	<i>Um</i>
M136	4011707064	ANELLO BLOCCAGGIO CUSCINETTO MEC 2-4000G	BEARING LOCKING RING MEC 2-4000 G	1	n
M137	5050107051	VITE M 6X10 TSEI	SCREW - M 6X10 TSEI	3	n
M138	4010601160	COPERCHIO SCATOLA MOLT. HM MEC 2-8000	GEARBOX COVER - MEC 2-8000 HM	1	n
M139	5020400034	MOTORE IDRAULICO ORBITALE 130 CC	ORBITAL HYDRAULIC MOTOR 130 CC	1	n
M140	4020507017	INGR. CON ALBERO MEC2-5000/HM Z55-M2,5	GEAR WITH SHAFT MEC2-5000/HM Z55-M2,5	1	n
M141	5050107072	VITE M 12X30 TCEI	SCREW - M 12X30 TCEI	2	n
M142/3	6080200219	MOTORE IDR. KM 30.27 SO GR.3 COMPL.	HYDRAULIC MOTOR KM 30.27 SO GR. 3	1	n
M142/3,5A	6080200056	MOTORE IDR. KM 30.43 SO GR.3.5 COMPL.	HYDRAULIC MOTOR KM 30.43 SO GR. 3.5	1	n
M142/3,5B	6080200057	MOTORE IDR. KM 30.51 SO GR.3.5 COMPL.	HYDRAULIC MOTOR KM 30.51 SO GR. 3.5	1	n
M143	4030108046	GUARN. SUPP. MOTORE IDR. GR. 3-3.5 MEC	HYDR. MOT. SUPP. GASKET - GR. 3-3.5 - MEC	1	n
M144	5050107054	VITE M 10X35 TE	SCREW - M 10X35 TE	4	n
M145	5050107044	VITE M 10X20 TCEI	SCREW - M 10X20 TCEI	6	n
M146	5050207030	RONDELLA D 6X17X3 - DIN 6340	WASHER - D 6X17X3 - DIN 6340	2	n
M148	5050107018	VITE M 10X16 TE	SCREW - M 10X16 TE	1	n
M149	4010406037	FLANGIA RIDUZ. CURVA OR. D 45 - MEC 2000	REV. ELB. CONNECT. FLANGE D45 - MEC 2000	2	n
ME118	6010201004	KIT REVISIONE POMPA MEC 3000 STANDARD	REBUILD KIT - MEC 3000 STANDARD	1	n
MEC118	6010201005	KIT REVISIONE POMPA MEC 4000 STANDARD	REBUILD KIT - MEC 4000 STANDARD	1	n
M118/SP	6010201016	KIT REVISIONE POMPA MEC 2000 LONG LIFE	REBUILD KIT - MEC 2000 LONG LIFE	1	n
ME118/SP	6010201017	KIT REVISIONE POMPA MEC 3000 LONG LIFE	REBUILD KIT - MEC 3000 LONG LIFE	1	n
MEC118/SP	6010201018	KIT REVISIONE POMPA MEC 4000 LONG LIFE	REBUILD KIT - MEC 4000 LONG LIFE	1	n
LUBR_OIL	5070200100	OLIO BATTIONI PAGANI POMPE (5LT)	BATTIONI PAGANI VACUUM PUMP OIL (5LT)	1	n



Battioni®
Pagani

Setting the pace since 1953

0	15.01.2018	1° EMISSIONE	PROG	R DT	AM
REV.	DATA	MOTIVO	PREPARATO	APPROVATO	AUTORIZZATO



Battioni®
Pagani

Setting the pace since 1953

Via Cav. Enzo Ferrari, 2
43058 Ramoscello di Sorbolo (PR) - Italy

Ph. +39 0521 663203

Fax +39 0521 663206



www.bapag.it
info@bapag.it